



Service Manual

MS-2931

Ver.10 (s/n 20001018) Aug '99

**Used in Airline Pilots DX
F355 Deluxe
(Triple monitor games)**

**200-5710 - monitor
5784 - chassis
5820 - neck bd**

MS-2931

Service Manual Version Trace

Version No.	S/N	Set Revision	Revised	Pub. Date
10	20001018~	-	1" production	Aug. '99

●Table of Contents

Important Notice for Servicing Monitors

	General Notice	1
	Precautions for Servicing	3
	Before Returning to The Owner	10

SECTION I : SPECIFICATIONS

1.	CRT SPECIFICATIONS	I-1
2.	ELECTRICAL SPECIFICATIONS	I-3
3.	MECHANICAL SPECIFICATIONS	I-9
4.	CERTIFICATIONS & STANDARDS	I-15
5.	RELIABILITY & SAFETY	I-16
6.	OPERATING ENVIRONMENT SPECIFICATIONS	I-16
7.	PACKAGING SPECIFICATIONS	I-17

SECTION II : CIRCUIT DESCRIPTION

1.	Power circuit	II-1
2.	Protection Circuit	II-3
3.	Sync Processing, ABL and Blanking (BLK) circuit	II-5
4.	Horizontal circuit	II-6
5.	High Voltage circuit	II-8
6.	Vertical Deflection circuit	II-9
7.	Video Amplified Circuit	II-10

SECTION III : ADJUSTMENT CONTROL

1.	Name	III-1
2.	Adjustment by OSD	III-1
3.	Other adjustment	III-3
4.	Special Function	III-3

●Table of Contents

SECTION IV : ADJUSTMENTS

1. Factory Adjustment	IV-1
1.1 Factory adjustment mode	IV-1
1.2 Factory adjustment menu	IV-1
2. General Adjustment	IV-2
2.1 Signal	IV-3
2.2 Preset	IV-3
2.3 Before the adjustment	IV-4
2.4 Adjustments	IV-4
A +B Voltage Adjustment	IV-4
B Preset	IV-4
C Input connector check	IV-4
D H.Sync check	IV-5
E High Voltage adjustment	IV-5
F X ray protector adjustment	IV-5
G X ray protector confirmation	IV-5
H H. drive adjustment)	IV-6
I Screen adjustment	IV-6
J Focus adjustment	IV-6
K Degauss circuit confirmation	IV-6
L H. Position Adjustment	IV-6
M V.Linearity Adjustment	IV-7
N Distortion correction	IV-7
O Size/position adjustment	IV-7
P H/V Size Limit adjustment	IV-7
Q White balance adjustment for dark area	IV-8
R BRIGHT adjustment	IV-8
S Center brightness adjustment	IV-8
T White balance adjustment for bright area	IV-8
U ABL adjustment	IV-8
V ITC adjustment	IV-8

SECTION V : TROUBLESHOOTING

SECTION VI : APPENDICES

Parts List
Electric Diagram

Important Notice for Servicing Monitors

●General Notice :

This service manual is prepared to assist service organizations or engineers who are in charge of servicing monitors in the field. This manual, therefore, is not for end users but for those technically oriented service engineers from distributors, dealers, VARs and other wholesalers or retailers who are capable of servicing the unit.

This manual explains the monitor's outline, detailed features, functions, basic construction of the individual unit and the circuits, sophisticated adjustments and detailed troubleshooting procedures for NANA O monitors.

Please read and understand this manual before attempting service.

This manual uses the following conventions.

DANGER

It indicates a potentially hazardous situation which, if not avoided, will result in death or serious injury.

WARNING

It indicates a potentially hazardous situation which, if not avoided, could result in death or serious injury.

CAUTION

It indicates a potentially hazardous situation which, if not avoided, may result in minor or moderate injury and/or property-damage.



It indicates a prohibited action.



It indicates a general caution.



It indicates a caution which, if not avoided, may result in electric shock.

 DANGER

- 1) The monitor contains high voltage circuit. Only experienced service personnel should perform repairs or service work on high voltage monitors.

When the cabinet of the monitor is removed and the monitor is operating, there is a risk of an electric shock hazard.



- 2) When designing and manufacturing the equipment or the product by using the monitor, realize the monitor feature and consider the safety.



- 3) Never modify any part of the equipment without permission by authorized party.

NANAO corporation will not be responsible for any damage or incident caused by an unauthorized modification.

 WARNING

- 1) Unplug the power cord before servicing.

Ensure the power cord is disconnected before replacing any parts in the unit. There is a risk of the electric shock hazard or damage.



- 2) Do not wear any metal or accessories.

There is a risk of an electric shock.

●Precautions for Servicing :

1. General

WARNING



- 1) **Do not connect or disconnect any wires or connectors while the monitor is in operation.**

It may result in damage to the circuit or may cause an electric shock.



- 2) **Do not short any portion of any circuit while the monitor is in operation.**

This will cause smoke, electric shock or damage to the transistors, ICs or other parts or circuit in the unit. (*Excluding the Adjustments only when specified.)





- 3) **Do not change the original design of the monitor.**

This will cause smoke, electric shock or damage to the circuit.

- 4) **Replace only with the exact factory recommended spare parts.**

The use of unauthorized substitute parts may cause an electric shock, damage to the monitor, or may exceed the specified X-ray radiation.

- Safety related parts Parts List : "S" Circuit Diagram : "
 - X-ray related parts Parts List : "X" Circuit Diagram : "
 - Anti-static related parts Parts List : "A"
 - Moisture protection related parts Parts List : "M"
-

CAUTION



- 1) **Do not touch the sharp edge of the chassis.**

It may result in injury.

2. Precautions for Servicing CRT

⚠ WARNING

- 1) **Disconnect the Power Cord, and completely remove static charge before taking off the Anode Cap.**

When discharging high voltage, be sure to disconnect the power cord.

Connect a 10k Ω resistor (1W and over) and a insulator wire(such as a test probe) between CRT dag and the Anode Button.

If the High Voltage is not removed, you will get an electric shock by touching the Anode Cap area.

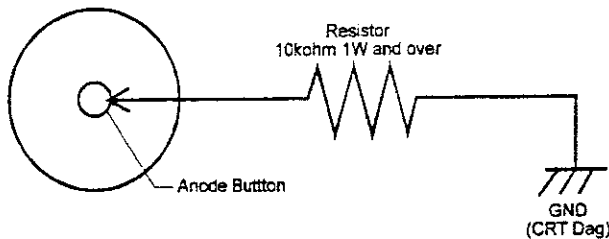
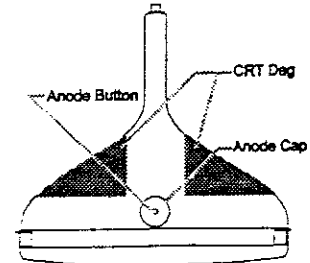

- 2) **Replace with a CRT of the same type number for continued safety.**

The CRT used in this monitor employs integral implosion protection.

If the CRT is replaced with a different type, it will result in an improper circuit function, exceed the specified Safety Standards range, or affect the picture quality guaranteed in the specifications.

- 3) **Use only CRT and PCB cording the same serial number.**

Apply silicon grease around anode button when putting anode cap on. Please make sure that only other material is not attached around contact area.

- 4) **Pay your attention to CRT neck and PCB-CRT. Do not touch them to the other material.**

This will cause the damage.

- 5) **Follow the instructions below when mounting the Anode cap.**

Surely mount the Anode cap and paint the silicone grease. High voltage may leak from the Anode cap and there is a risk of electric shock and damage.

- (1) Clean up around the Anode button and inside of the Anode cap.
- (2) Paint the Silicone grease equally around the Anode cap with a paint-brush.
(Recommended grease; KS-650N, Shinetsukagaku)

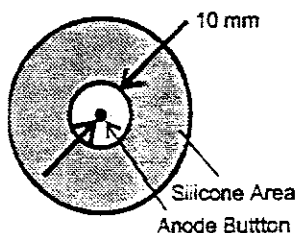

Do not paint inside of 10mm.

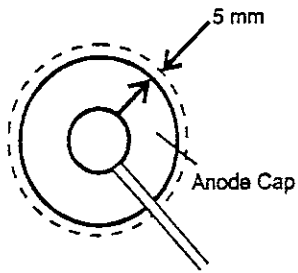

Over-painted area may be less than 5mm.

- (3) Lock the hook inside of the Anode cap onto the Anode button and attach the X-ray protection metal onto the Anode button surely.

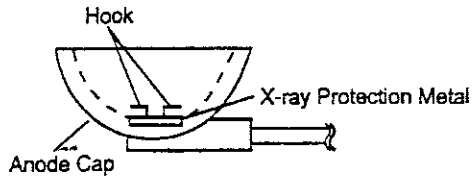

- (4) Confirm that the Anode cap is completely stuck on the surface and any partial tearing or lifting of it should not be recognized.
 - (5) Confirm that the Silicone grease is painted 5mm beyond the Anode cap brim.
-
-

CAUTION



1) Do not lift the CRT by the neck.

The neck of the CRT is not firm enough to hold the entire CRT. Hold the CRT under your arms when lifting it. In case the CRT is dropped, it could result in injury.

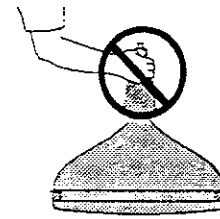

2) Be careful about the followings to keep the special coating for anti-static and good contrast.

- (1) Do not absorb the CRT surface with a vacuum absorption machine. It may damage the coating of the surface.
 - (2) Use a soft cloth to remove dust from the screen. If necessary, stubborn stains can be removed by moistening part of a cloth with water or alcohol (ethanol, methanol, or isopropyl alcohol) to enhance its cleaning power.
Never use cleaners including abrasives or bleacher.
 - (3) Do not scratch or press on the surface with any sharp objects, such as pencil or pen as this may result in damage to the CRT.
 - (4) When carrying the monitor, do not scratch or press on the surface with any sharp objects, such as pencil or pen as this may result in damage to the CRT.
 - (5) Do not paste any seals on the screen. It may make some marks because of the ultra violet rays.
 - (6) Never remove four aluminum foil tapes each corners of the screen. It may result in decrease the anti-static effect.
 - (7) Do not give any impact to the CRT. If you give the impact to the CRT when using the monitor on face top style, there are more internal sparks of CRT than TV style. The internal spark is caused by the coating inside of the CRT that comes off and drops to the guns. Therefore, the impact to the CRT on face top style causes frequent internal sparks and improper Cut Off adjustment of the CRT that makes the screen invisible and loses the white balance. Also, the screen disappears for a moment when the spark occurs.
-

3. Electrical Circuit

WARNING



- 1) **Do not touch the +B Voltage and High Voltage terminals inside the monitor.**

The circuits of the monitor is divided into the Primary part and Secondary part which both are insulated. Do not touch the Primary or the Primary and the Secondary at the same time. And do not short both parts. If carelessly contacted, it can cause serious shock or result in damage to the monitor.

When adjusting, use some dielectric tools and do not touch any other volumes than adjustment ones.

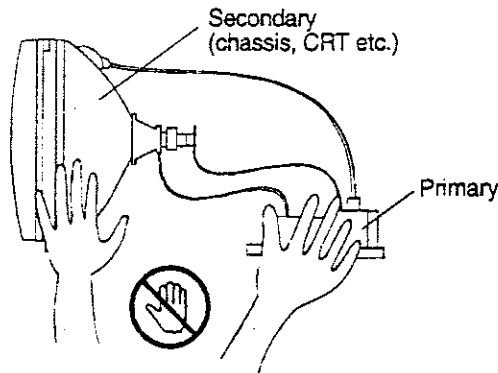

- 2) **Do not touch the inside of the monitor when operating. There is a part generating high voltage more than 20000V inside of the monitor.**

If necessarily, unplug the power cord before touching.

If an object such as solder or paper falls into the monitor, unplug it immediately. It can cause smoke, electric shock or damage to the circuit.

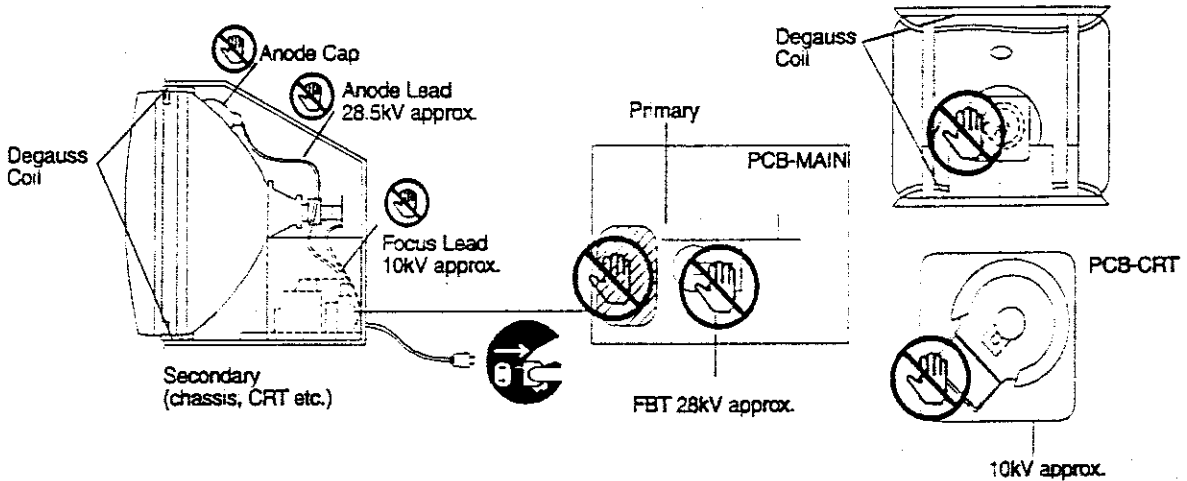



3) **Do not operate the monitor with a High Voltage level exceeding the specified range below.**

Failures in the High Voltage Adjustment can increase X-ray radiation. The maximum High Voltage range specified for operating the monitor is as below.

Specified Power Supply : 100~120V, 220~240V, Beam Current : zero

High Voltage level : 28.0 ± 0.6 kV

To check for the presence of High Voltage, use an accurate high impedance High Voltage Meter connected between the Anode Button and the CRT dag.

It may cause a rise in the voltage when the Power Supply Voltage is out of the specifications range.



4) **Do not clamp the high voltage lead (the red lead from FBT) with any other leads.**

The high voltage or static electricity may cause an electric shock or damage to the circuit.

5) **Connect the coating earth to the PCB-CRT.**

Otherwise, it may cause an electric shock.

6) **Use 2 pin power plug of the Digital voltage meter.**

Otherwise, an electric shock, damage to the circuit or breaker-down may occur.

7) **When checking wave on the primary voltage line, use the 2-pin power plug of oscilloscope. Do not connect GND on the primary circuit and GND on the secondary circuit (chassis).**

If not, this may cause electric shock, damage to the circuit or breaker-down.



8) **Do not check on the primary and secondary voltage line with same oscilloscope at the same time. If necessary, connect the Isolation Transformer for the power of monitor.**

This may cause an electric shock or damage to the circuit.

4. Others

WARNING



1) **Take care not to scratch the coating of the Degauss Coil.**

Degauss Coil circuit is on the primary voltage line. When the coating of the Degauss Coil is damaged and the Coil directly touches the chassis or screws, the chassis voltage will become the same as the primary voltage line. This can result in hazardous danger as follows.

- (1) Electric Shock
- (2) Short (Current Leakage)
- (3) Degauss does not work
- (4) Circuit Damage
- (5) Damage of connected computers or peripherals. It can result in a hazardous fire or electric shock. Follow the instructions below.



2) **Do not bring any sharp objects such as the edge of the chassis close to the degauss coil, FBT, the anode lead and the focus lead.**

This may cause an electric shock or damage to the objects connected.

CAUTION

- 1) If you touch the CRT surface, you may feel a slight electric shock. This is caused by the static electricity being produced on the CRT surface and it does not affect the human body.
 - 2) When bringing one monitor close to another monitor, make sure the monitors' structure and setting. If one monitor has the different vertical frequency, another monitor image may flicker.
 - 3) If you shift horizontal position of the monitor until a part of the displayed image disappears, the image may be dark. This is not problem for monitor reliability. Readjust to gain the best position.
-

●Before Returning to the Owner :

To protect your customers, perform the following safety checks before returning the monitor.

A. Observance

WARNING

- 1) Testing equipment should be isolated by putting an insulating board in between.

When the back cabinet of the monitor is removed and the monitor is operating, there is a risk of an electric shock.

- 2) Keep people away during the test.

When the back cabinet of the monitor is removed and the monitor is operating, there is a risk of an electric shock.



- 3) Do not wear any metal or accessories.

There is a risk of an electric shock when the circuit is shorted.

B. Test Procedure

DANGER

When any portion of the chassis is short-circuit caused by a leakage of primary voltage line, the conductive area may become high voltage which can result in an electric shock or other hazardous danger.

1) Withstanding Voltage Check

Impress AC voltage between a conductive chassis and the line of the AC cord for 1~2 seconds when the Main Power Switch is ON. The buzzer of the testing equipment should not be NG.

100~120V: 1200 VAC (Electric current sensitivity: 5mA)

C. Safety Checks

- 1) Check and see that all the connectors are tightly inserted.
 - 2) Check and see that all the harness wires have been clamped as specified.
 - 3) Check and see that any lead wires are not caught between the chassis and other metal parts in the monitor.
 - 4) Check and see if the following important works for safety are surely performed.
 - The VR721 (HV ADJ), VR711 (X-Pro) is surely locked with the silicone rubber after adjusting.
 - The Anode Cap and the Anode Rings are surely equipped.
 - 5) Check and see if the following important indications for safety are surely indicated.
 - The Label-HV is surely indicated near the anode of FBT, the Focus and Screen Lead, the DY Lead and the anode of CRT.
 - The Name Plate is surely put on the chassis.
 - The Label-HV-Fuse, the Label-DHHS and the Label-PTB-2932 are surely indicated on the CRT or the chassis.
-

SECTION I : SPECIFICATIONS

1. CRT SPECIFICATIONS

Type	A68LBT696X
Trio Pitch	Horizontal: 0.8 mm (Center), 0.9 mm (Edges) Vertical: 0.6 mm
CRT Surface	Anti-Static Coating
Light Transmission	49.0 % approx.
Surface induced voltage	Less than 1.5 kV within 8 seconds after power SW on.

1-1 Limitation of M.P.D.(Missing Phosphor Dots) for CRT

This limitation of M.P.D is applied to the effective screen (phosphor area). In the other screen area, limited are no other defects than scratches preventing the anti-static effective in aluminum foil taped area.

Width (mm)	Max. Length (mm)
less than 0.05	No limit
0.06-0.13	50
0.14-0.20	19
more than 0.21	-

1-2 CRT Dimension

A68LBT696X

Unit: mm

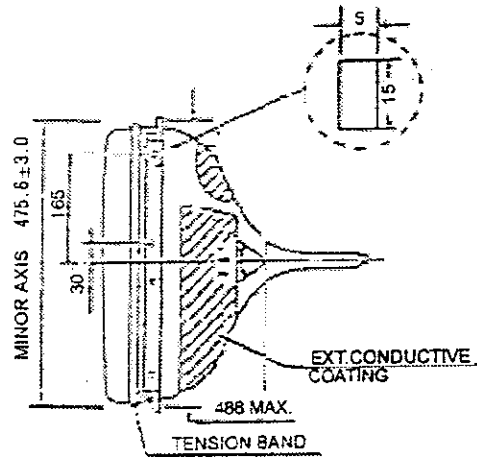
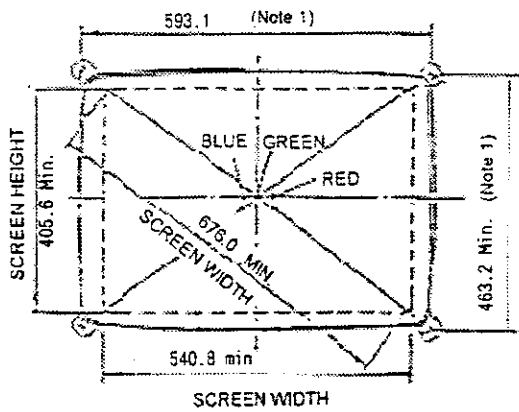
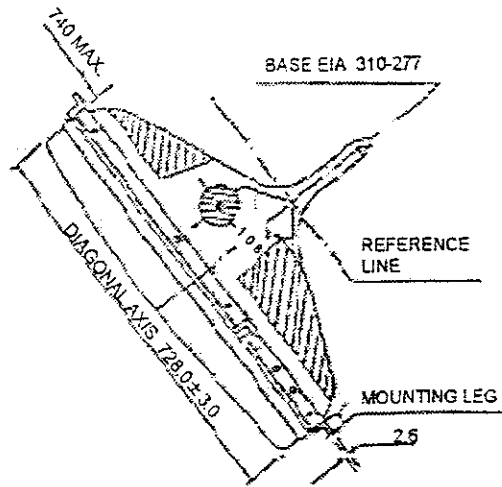
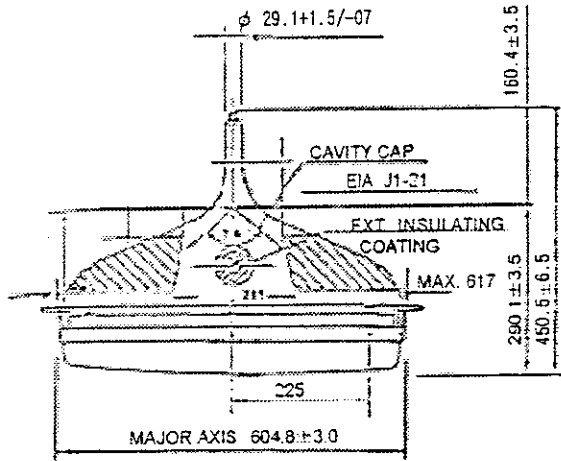

Curvature of the screen

- Diagonal: R2390
- Horizontal: R2400
- Vertical: R2440

2. ELECTRICAL SPECIFICATIONS

All measurements are subject to the conditions below, unless otherwise specified.

Input signal	Mode 1: 15.74kHz, ST-V GOLDEN AXE THE DUAL supplied by SEGA Mode 2: 24.39 kHz, Model 3 (24k) supplied by SEGA Mode 3: 31.67 kHz, Model 3 (31k) supplied by SEGA Refer to 2.5 "Recommended signal timing chart".
Brightness	33% window pattern : 60 ft-L, white field pattern : 32 ft-L, black field pattern: 0 ft-L
Magnetic field	BH : 30 μ T, BV : 35 μ T
Measurement	After warm up for at least 30 minutes
Display area size	540 mm x 405 mm
Ambient temperature	20 C°~ 30 C°
Setting conditions	TV style The screen faces the east and the adjustment volumes and switches are in default settings, unless otherwise specified.

2.1 Deflection

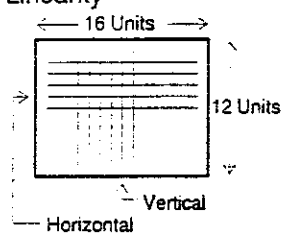
Items	Values	Conditions
Scanning Frequency	Horizontal: Mode 1: 15.75 kHz \pm 300Hz Mode 2: 24.4 kHz \pm 500Hz Mode 3: 31.5 kHz \pm 500Hz Vertical: 55 ~ 65 Hz	
Retrace Time	Horizontal: Mode 1, 2: 6.0 μ s max. Mode 3: 5.0 μ s max. Vertical: 1.0 ms max.	
Linearity 	Horizontal: \pm 10 % max. Vertical: \pm 8 % max.	To be measured with Cross-hatch pattern As obtained through following formula. $H = \frac{\{(X \text{ max. or } X \text{ min.}) - (X \text{ Ave.})\}}{(X \text{ Ave.})} \times 100$ $V = \frac{\{(Y \text{ max. or } Y \text{ min.}) - (Y \text{ Ave.})\}}{(Y \text{ Ave.})} \times 100$
Display area size, position	According to 2.7 Adjustment specifications	
Valid display area size	540 mm x 405 mm	
Display ability	Full scan the recommended timing shown 2.6	
Distortion	(a) Trapezoidal: 3.0 % max. (b) Barrel/Pincushion: 3.0 % max. (c) Tilt: 2° max.	To be measured based on JIS-C6101

2.2 Display

Items	Values	Condition
Center Resolution	676 dots x 676 lines	As obtained through following formula. Center Resolution = Display area size / Center phosphor pitch
Video Bandwidth	28.4 MHz typ. (at -3dB)	

2.3 ITC Performance

Items	Values	Condition
Color Purity	Conspicuous different colors shall not be recognizable with Red-field pattern against all directions after the internal dégaussing.	To be degaussed in each direction.
Convergence	Max. deviation among RGB raster line center distances, either horizontal or vertical, shall not exceed the following: <ul style="list-style-type: none"> • Within a circle whose diameter is equivalent to 60 % of V. length of CRT: 1.5 mm max. • Within a circle whose diameter is equivalent to vertical length of CRT (excluding the above circle): 2.5 mm max. • Within CRT screen (excluding the above circles) : 3.0 mm max. 	
Jitters	To be invisible from the distance of 50 cm from CRT surface.	
White Balance	x : 0.285 ± 0.02 y : 0.285 ± 0.02 Color Temperature 9700K approx.	To be measured at center of a white-window pattern with Bright VR and Contrast VR in adjusted settings.
Focus	To be adjusted best.	
Maximum brightness	60 ± 10 ft-L	Input signal 0.7 Vp-p To be measured with a white field pattern.

2.4 Power Supply

Items	Values	Condition
Input current and voltage	100-120 VAC ± 10 %, 50/60 Hz	
In-rush current	72 A peak max.	At 132 VAC
Power Consumption	120 ± 18 W	To be measured in default settings with a white field pattern. (The CONTRAST VR is Max.)

2.5 Signal Input

Sync Input Signal Form	(a) H/V Separate, Positive/Negative (b) H/V Composite, Negative
Video Input Signal Form	AMP UP: analogue, Positive, 3 Vp-p/2kΩ D-Sub : analogue, Positive, 0.7 Vp-p/75Ω
Scanning	Non-Interlace

2.6 Recommended Signal Timing Chart

Mode 1

At 15.734 kHz

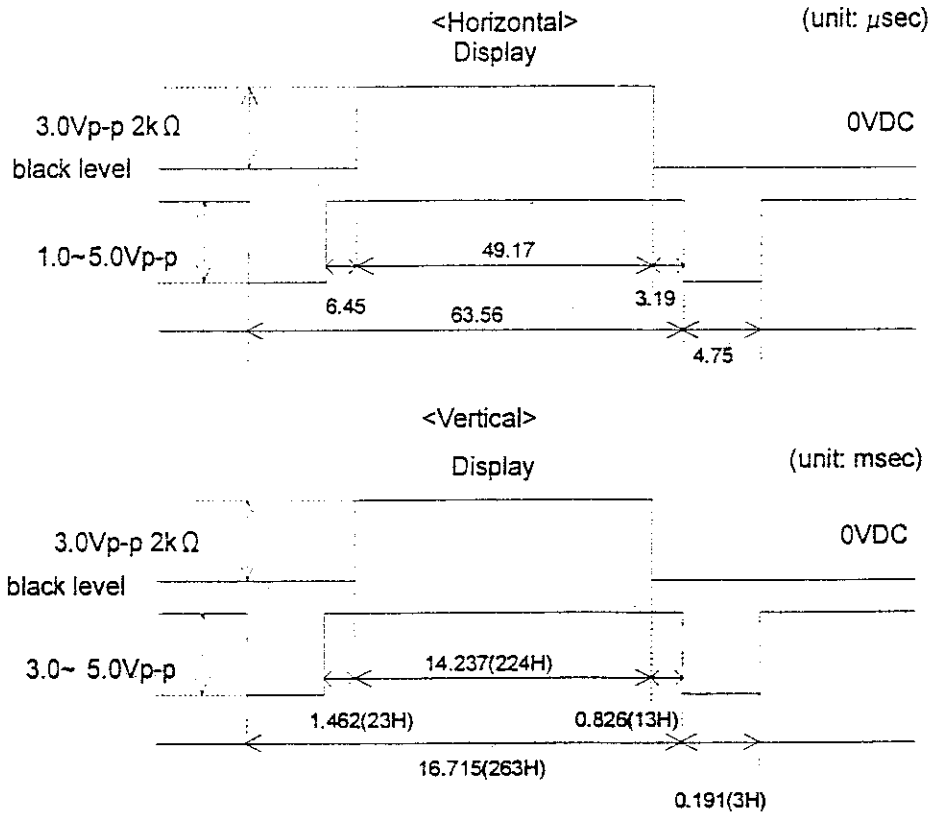

Mode 2
At 24.39 kHz

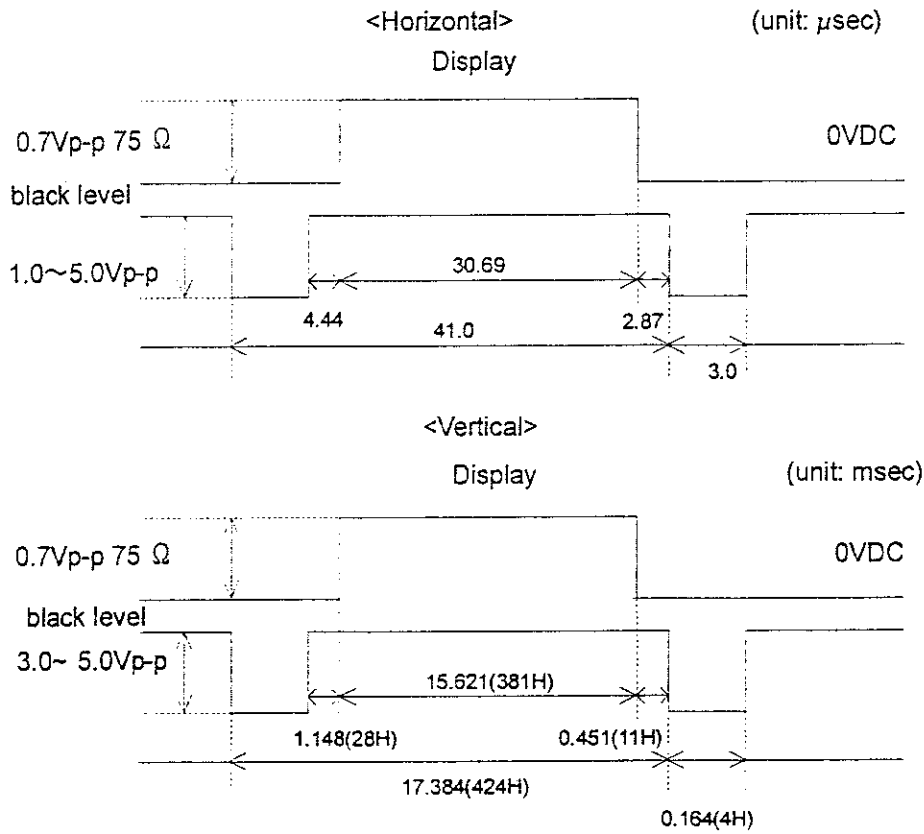

Mode 3
At 31.67 kHz

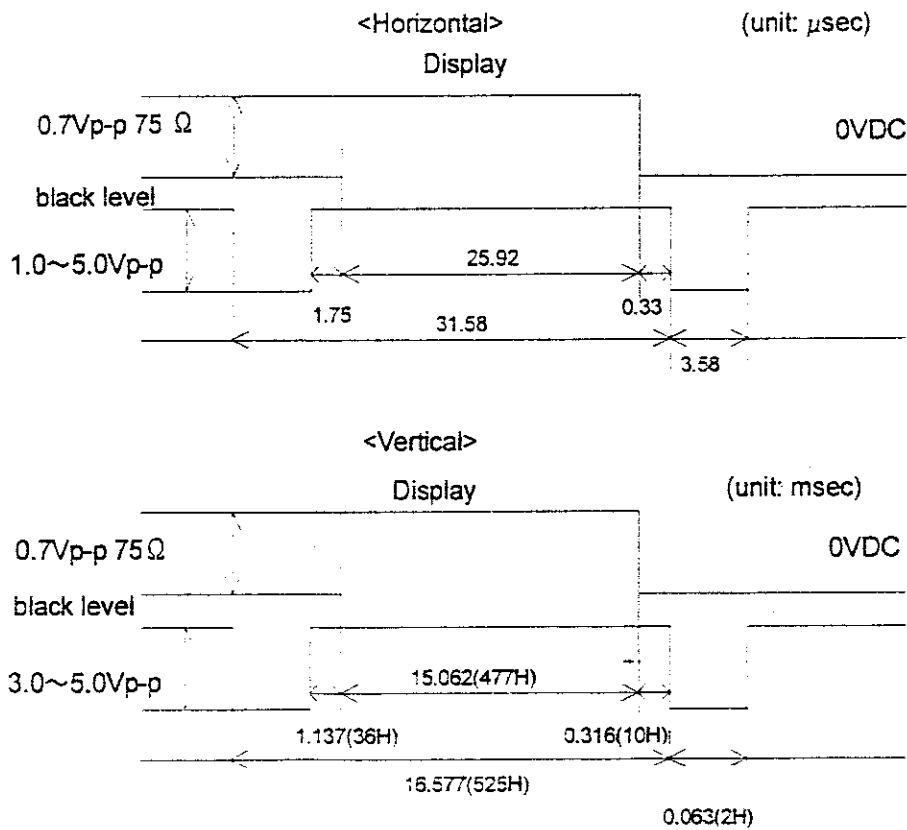

2.7 Block Diagram

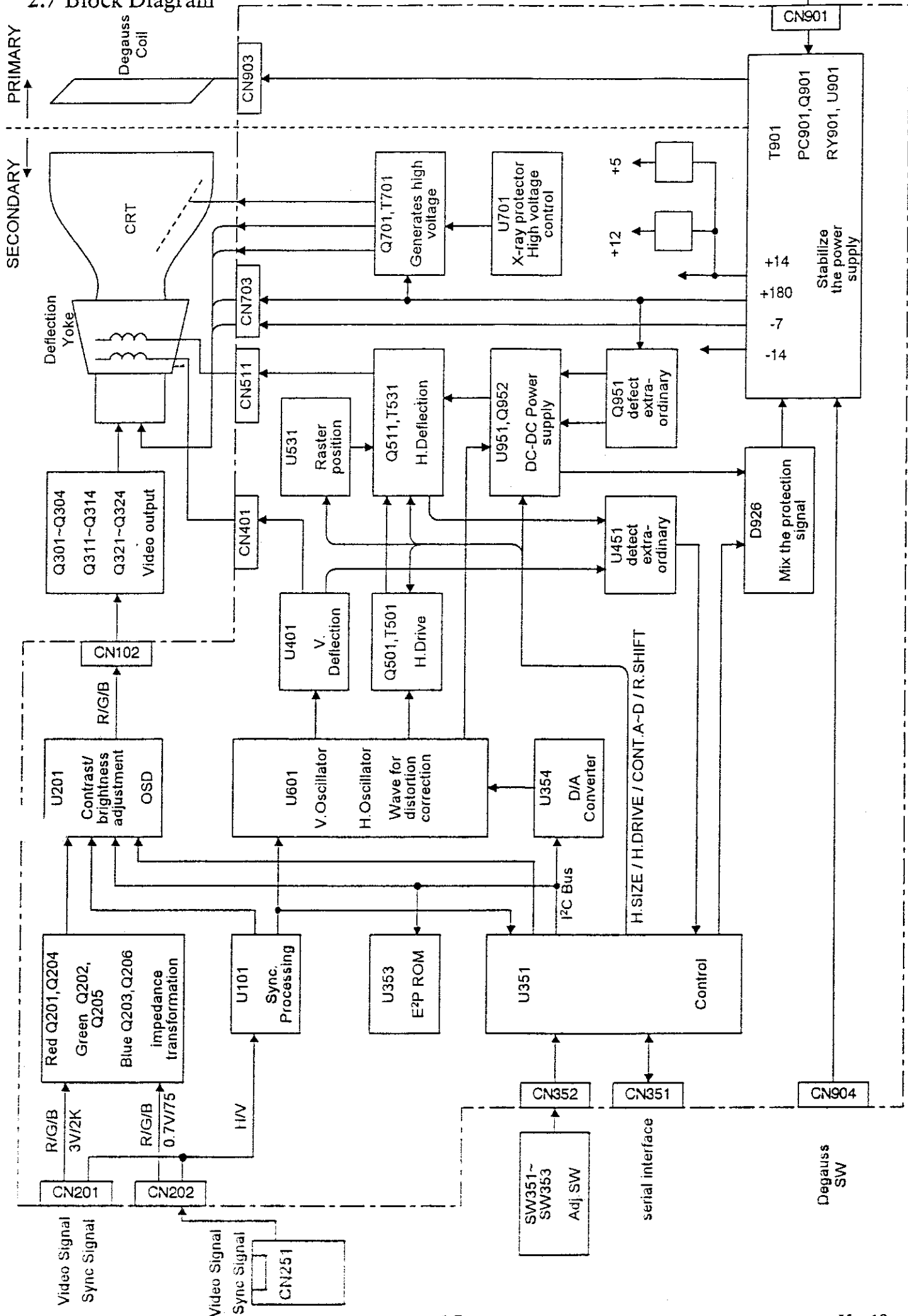

2.8 Adjustment Specifications

2.8.1 Standard signal used for the adjustment

Use the following 3 modes.

- 1) Mode 1: ST-V GOLDEN AXE THE DUAL supplied by SEGA
- 2) Mode 2: Model 3 (24k) supplied by SEGA
- 3) Mode 3: Model 3 (31k) supplied by SEGA

2.8.2 Adjustment Specifications

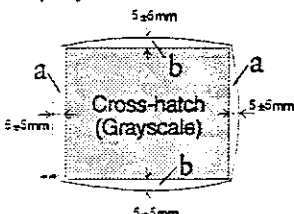
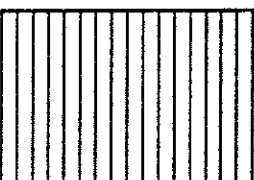
Items	Values	Conditions
<p>Display Area</p>  <p>Cross-hatch (Grayscale)</p>	<p>a. Horizontal edges : 5 ± 5 mm b. Vertical edges: 5 ± 5 mm</p>	<p>The screen shall face the east.</p>
<p>Scan Direction</p>	<p>The scanning shall start from left top corner when the monitor is set to face its anode button top.</p>	
<p>Display Position</p>	<p>To be centered.</p>	
<p>White Balance</p> <p>low ← → high</p>  <p>16 grayscale pattern</p>	<p>Conspicuous different white balance shall not be recognizable in low and high brightness part with 16 grayscale pattern. Low brightness level (1st gradation part) : 0</p>	
<p>Others</p>	<p>100% scanned in each signal. No extraordinary in each pattern.</p>	

3. MECHANICAL SPECIFICATIONS

3.1 Adjustment Functions (Please refer to Section III for the detail.)

3.1.1 PCB-SW The Function Key adjustment (OSD: On Screen Display)

- Vertical Position Adjustment (V.POSI)
- Horizontal Position Adjustment (H.POSI)
- Vertical Size Adjustment (V.SIZE)
- Horizontal Size Adjustment (H.SIZE)
- Contrast Adjustment (CONTRAST)
- Brightness Adjustment (BRIGHT)
- Degaussing function (DEGAUSS)
- Reset (RESET)

3.1.2 PCB-MAIN

- Switching the polarity of Deflection Yoke
- Focus Adjustment (FOCUS)

Do not adjust above volumes except the authorized service personnel.

3.2 Configuration

NOTE: All of the dimensions, weights and angles below are reference values.

Dimensions (net)	625 mm (W) x 594 mm (H) x 488 mm (D)
Weight (net)	approx. 40.0 kg
Outline drawing	Refer to the below.

top

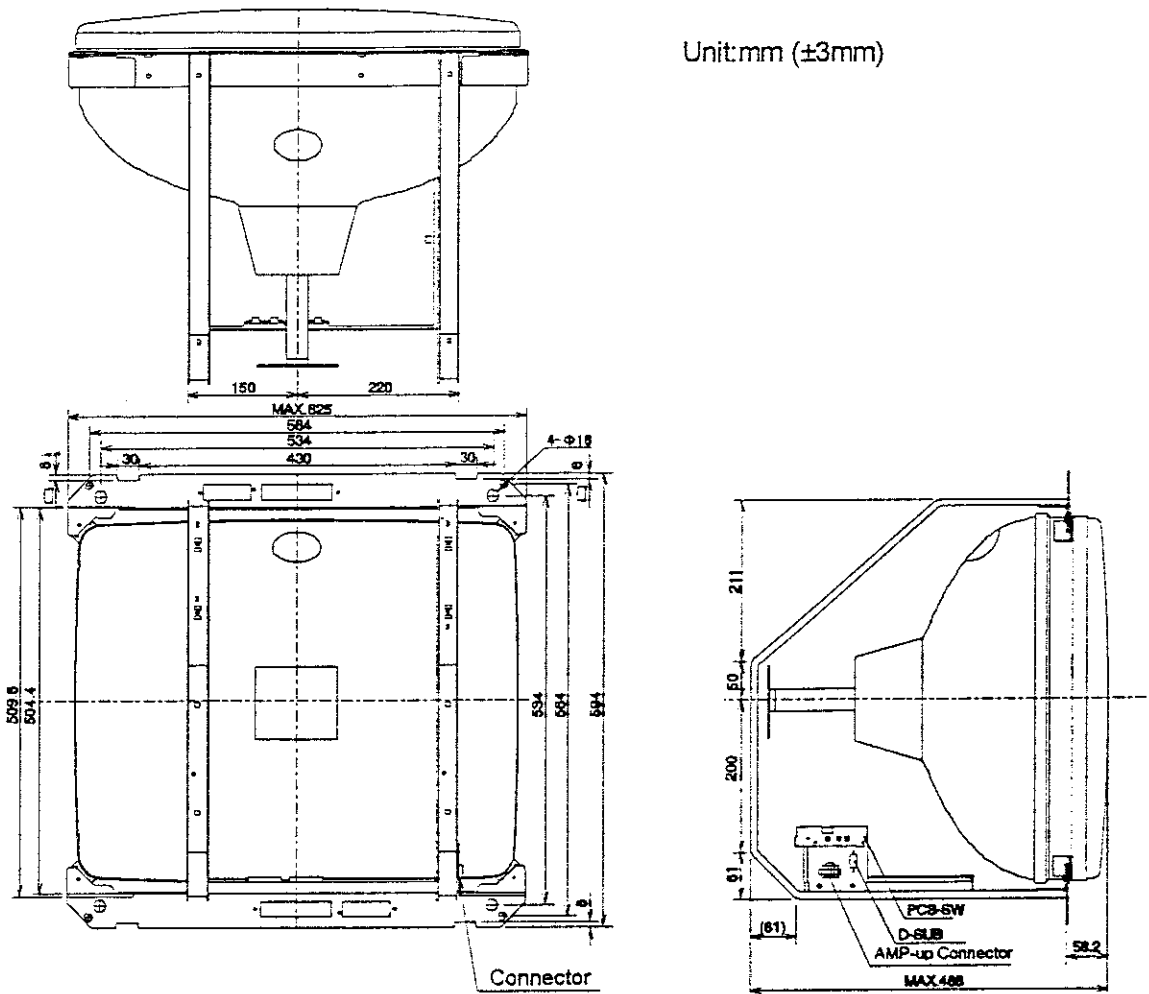

Rear

Side

3.3 Packing specifications (unit package)

NOTE: All of the dimensions and weight below are reference values.

Packing dimensions	756 mm (W) x 606 mm (H) x 728 mm (D)
Packing weight	approx. 45.0 kg
Stack limit	3 units (Maximum)
Packing drawing	Refer to page I-17.

3.4 Packing specifications (pallet package)

NOTE: All of the dimensions and weight below are reference values.

Packing dimensions	1090 mm (W) x 670 mm (H) x 850 mm (D)
Packing weight	approx. 108.0 kg
Stack limit	2 units (Maximum)

3.5 Connector Specifications

3.5.1 Connector Location

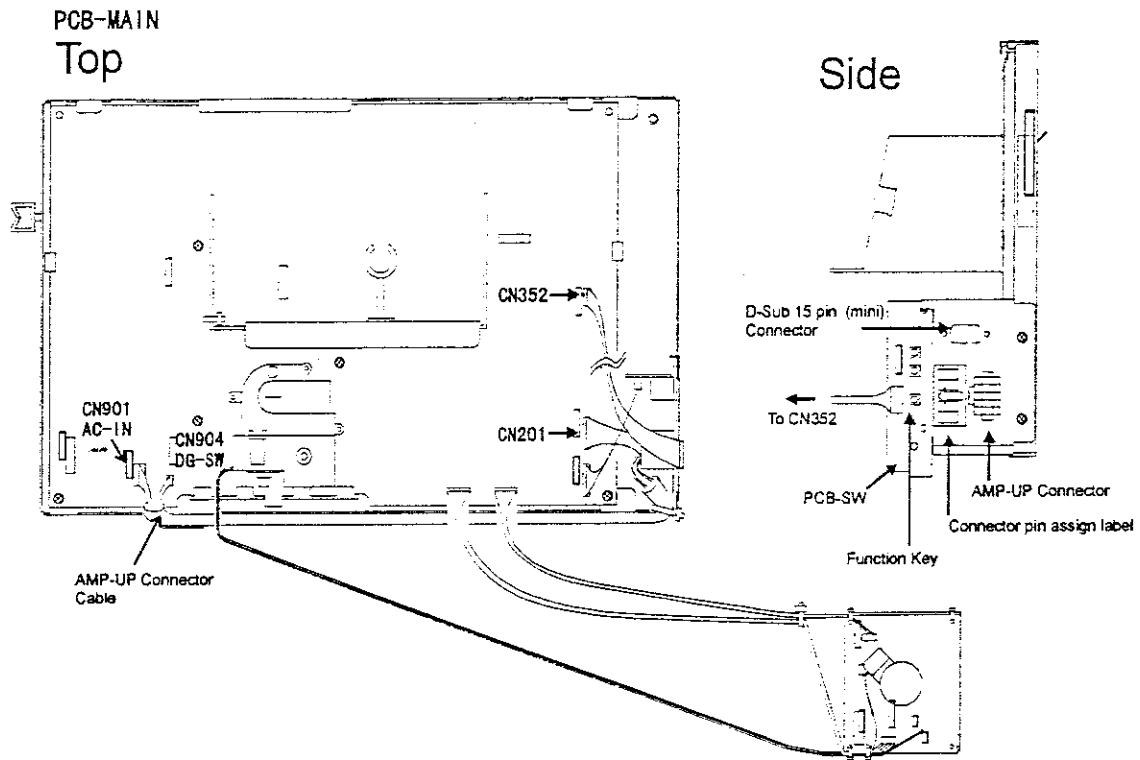

3.5.2 AMP UP Connector (176300-1)

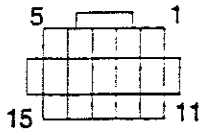

	Input Signal	Description
1	Red Video	Positive, 3Vp-p, Input imp. 2 kΩ
2	Green Video	Ditto
3	Blue Video	Ditto
4	H. Sync or H/V	Positive/Negative H. Sync 3-5 Vp-p Negative composite sync. 1-5 Vp-p
5	GND	GND
6	AC Power Supply	100-120VAC ± 10%, 50/60 Hz
7	AC Power Supply	100-120VAC ± 10%, 50/60 Hz
8	N.C (No Connection)	-
9	DEM	SW shall be connected between 9pin and 10 pin.
10	DEM	SW shall be connected between 9pin and 10 pin.
11	N.C	-
12	N.C	-
13	N.C	-
14	N.C	-
15	V.Sync. Signal	Posi/Nega V. sync 3-5 Vp-p

Connector Pin Assignment Label

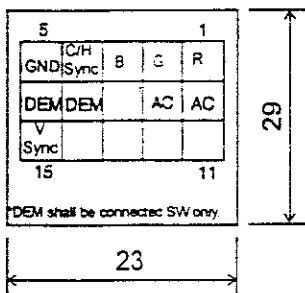

AMP UP Connector

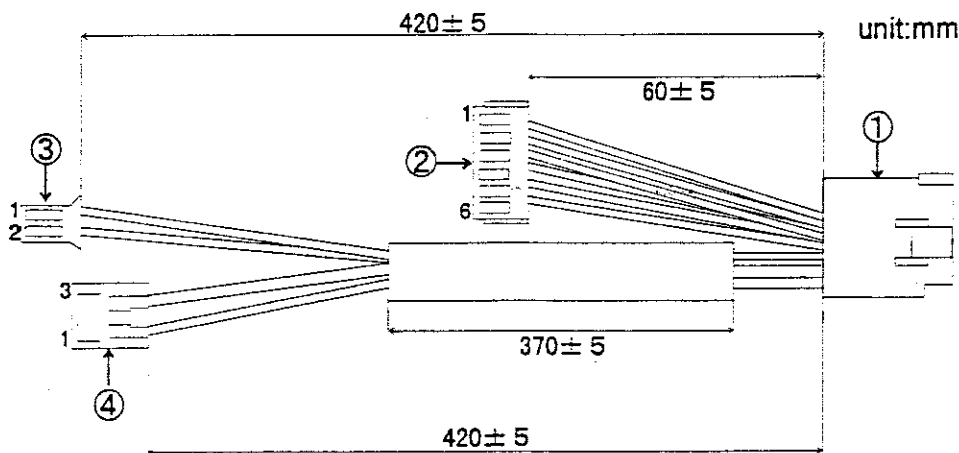

① UP Connector	② HER-6(connecting to CN201)
1 ②-6 Red	1 ①-15 Brown
2 ②-5 Green	2 ①-4 Gray
3 ②-4 Blue	3 ①-5 White
4 ②-2 Gray	4 ①-3 Blue
5 ②-3 White	5 ①-2 Green
6 ④-1 black	6 ①-1 Red
7 ④-3 White	③ PHR-2 connecting to CN904
9 ③-1 Red	1 ①-9 Red
10 ③-2 Orange	2 ①-10 Orange
15 ②-1 Brown	④VHR-3 connection to CN901
	1 ①-6 Black
	3 ①-7 White
8, 11~14pin Open	2pin Open

3.5.3 D-SUB 15 pin (mini) Connector

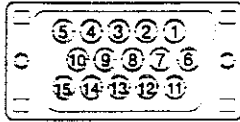

	Input Signal	Description
1	Red	Positive, 0.7Vp-p/75Ω
2	Green	Positive, 0.7Vp-p/75Ω
3	Blue	Positive, 0.7Vp-p/75Ω
4		
5	GND	GND
6	Red GND	GND
7	Green GND	GND
8	Blue GND	GND
9		
10	GND	GND
11		
12		
13	H.Sync or Composite Sync	Positive/Negative, Separate Sync, 3-5Vp-p Negative, Composite Sync, 1-5Vp-p
14	V.Sync	Positive/Negative, Separate Sync, 3-5Vp-p
15		

3.6 Conductive Aluminum Foil Tape Specifications

3.6.1 Name

TERAOKA 830

3.6.2 Dimension (reference values)

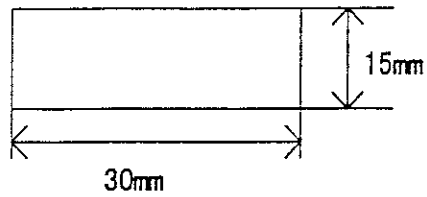

3.7.3 Taping

The aluminum foil tapes are put on to keep the surface of the panel and the integral implosion protection metal band conductive as follows (Since no problem is found in the mechanical and electrical performance.);

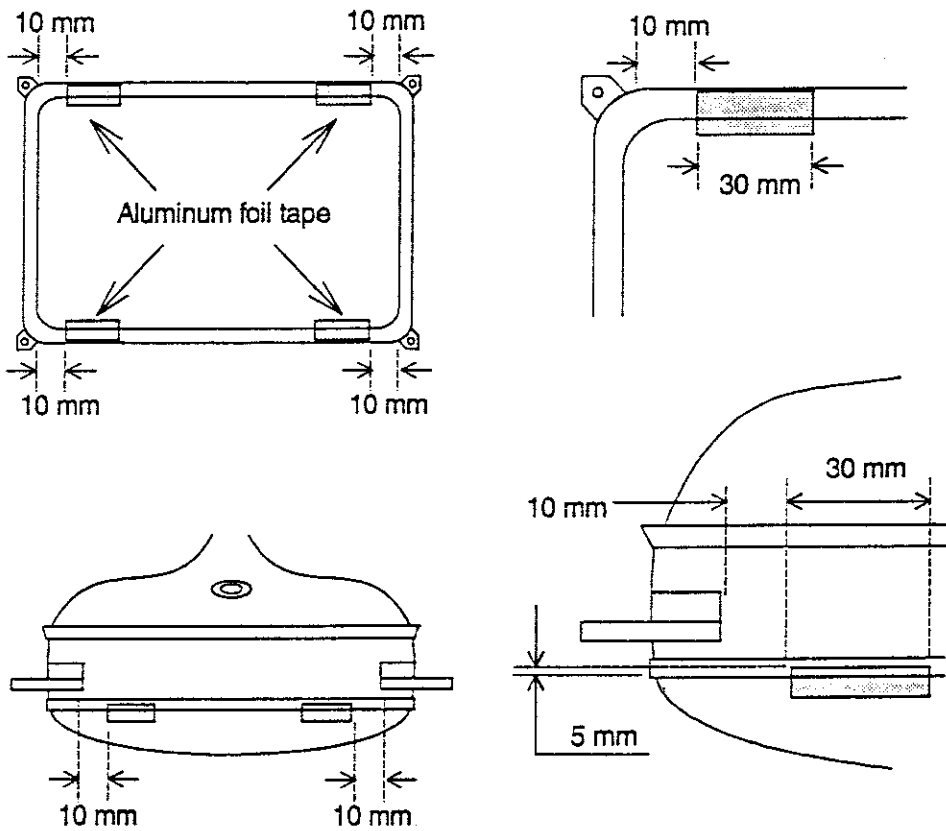

4. CERTIFICATIONS & STANDARDS

4.1 Certifications

Standard	Origin	Category				Marking
		Safety	EMC	Ergonomic	Other	
S-JQA	Based on Electrical Appliance & Material Control law (The 3 rd clause, Table No.8 "applied apparatus")	√				Name plate
TÜV	EN60950: 1991+A1+A2+A3	√				Name plate
CB	IEC60950: 1992+A1+A2+A3	√				
UL	UL 1950 2 nd	√				Name plate
C-UL	CSA C22.2 No. 950 2 nd	√				Name plate
DHHS (DNHW)					√ (X-ray)	
PTB*					√ (X-ray)	

4.2 Standards (excluding Video components)

Standard	Category				Marking
	Safety	EMC	Ergonomic	Other	
VCCI Class A		√			
FCC Class A		√			

INSTALLATION INSTRUCTION FOR SAFETY REQUIREMENT

The monitor should be installed in following condition in order to meet the requirement of safety standard EN60950: 1992+A1+A2+A3+A4+A11

1. Power Supply

- a) The transformer which has double or reinforced insulation should be used between primary power source and the monitor.
- b) The rating of input power supply voltage should be 100-120Vac \pm 10%.

2. Ambient temperature

The ambient temperature around the monitor should be less than 40°C.

5. RELIABILITY & SAFETY

5.1 Reliability

MTBF	20,000 hours at standard power input excluding CRT. *Values calculated according to the simplified "Parts Count Reliability Prediction" method as specified in MIL- HDBK-217F.
AC line noise resistance	No synchronized condition shall be detected when applying 500Vp-p pulse by using a noise simulator.

5.2 Safety Aspect

Undesired radiation	Less than 0.1 mR/hour (1 μ Sv/H) at 10 cm distance.
High voltage label	To be pasted on the followings. <ul style="list-style-type: none"> • Top of the anode cap • The anode lead • The focus and screen lead • The DY lead

6. OPERATING ENVIRONMENT SPECIFICATIONS

Ambient Temperature	Operation: 0 °C~40 °C Storage : -10 °C~60 °C (The inner temperature of the amusement machine should be designed below 40°C.)	
Ambient Humidity	Operation: 70 % R.H. max. Non condensing Storage: 80 % R.H. max. Non condensing	
Altitude	Operation: up to 3,000 m Shipping or Storage: up to 12,000 m	
Vibration	(Ass'y chassis unit)	To be free from any damage to the circuits nor the appearance on 1 hour 1 G vibration test to be carried out under 5~100~5 Hz varying frequencies in every 10 minutes. To be validated along all three axes.
	(Face-up)	To be free from any damage to the CRT on 1 hour 0.5 G vibration test to be carried out under 5~100~5 Hz varying frequencies in every 10 minutes. To be validated along the axes of the CRT.
	(Unit package)	To be free from any damage on 30 minutes 1 G vibration test to be carried out under 5~100~5 Hz varying frequencies in every 10 minutes. To be validated along all three axes.
	(Pallet package)	To be free from any damage on 40 minutes (or 1 hour in up-down vibration only) 0.5 G vibration test to be carried out under 5~100~5 Hz varying frequencies in every 10 minutes. To be validated along all three axes.
Drop Test	(Unit package)	To be free from any damage on free drop from 40 cm height once.
	(Pallet package)	To be free from any damage on free drop from 15 cm height and on drop with support (10 cm) from 15 cm height once.

7. PACKAGING SPECIFICATIONS

7.1 Unit package

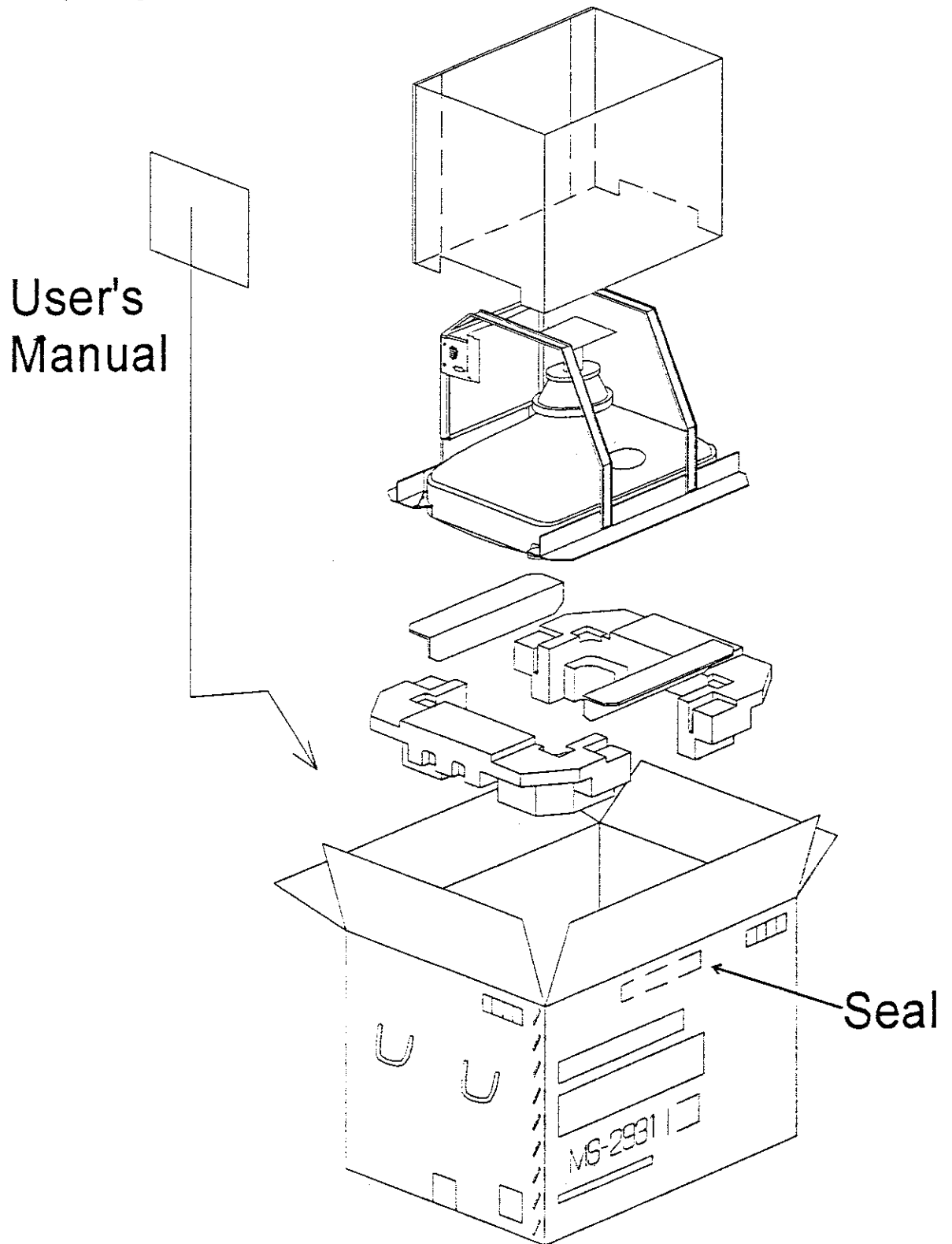

SECTION II : CIRCUIT DESCRIPTION

1. Power circuit

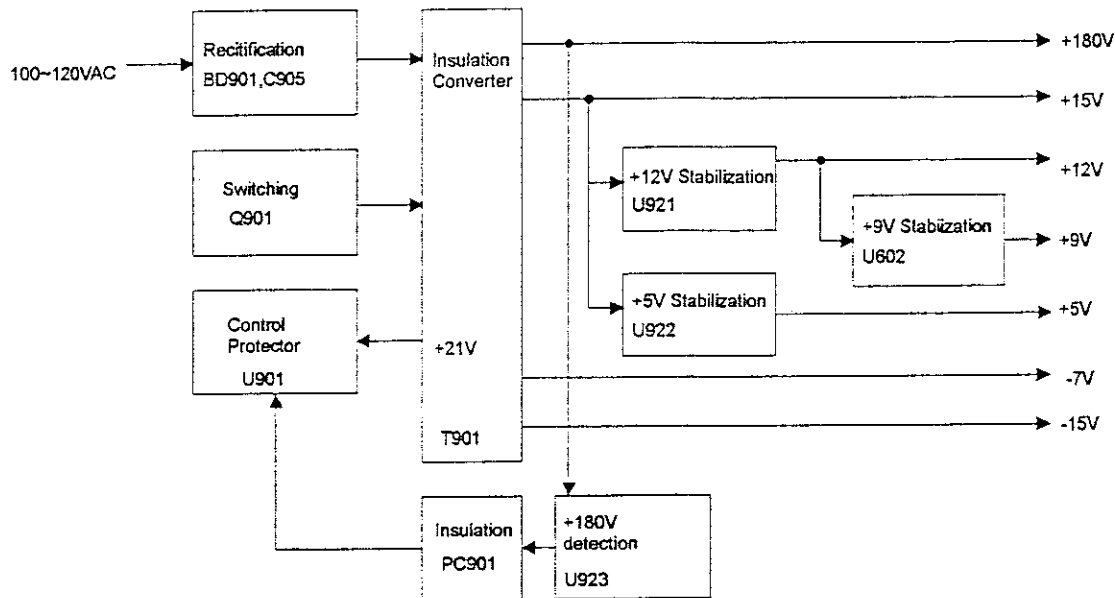

Power Circuit Block Diagram

This circuit generates insulated and stabilized DC voltage from AC power in order to supply the power for each circuit operation.

The following voltages are supplied to the each circuit.

- +180V: Chopper Power Circuit (Horizontal Deflection, High Voltage generating circuit, Video output circuit(In PCB-CRT)
- +/-15V: Vertical deflection IC (U401)
- +12V: Video amplifier IC (U201) , Chopper Power IC (U951) , High Voltage control IC (U701)
- +9V: Deflection IC (U601)
- +5V: Microprocessor (U351) , EEPROM (U353) , DAC (U354) , Sync. Processing IC (U101) , Video amplifier IC (U201)
- -7V: CRT heater

The 180V is stabilized as following order.

- The U923 compares the voltage divided from 180V output and internal standard voltage (2.5V)
- When the divided voltage is higher, the current is run to the PC901 (photocoupler) and the voltage at U901 9pin is heightened. The inverted amp output, the voltage at U901 8 pin is lowered.
- The current run into SW Q901 is detected at R907 and input to U901 4 pin.
- The U901 controls the pulse width of 1 pin by comparing the trisected voltage of U901 8 pin and

the voltage on 4 pin.

- When the 180V output is higher, the energy stored at T901 is reduced because the ON term of Q901 is shortened. Then the 180V is gone down and stabilized. The other voltages (+15V, -7V, -15V) are proportioned with 180V by the ratio of winding for T901.
- The +12V and +5V are generated from the +15V generated through the 3 terminal regulator. The +9V is generated from the +12V through the 3 terminal regulator.

2. Protection Circuit

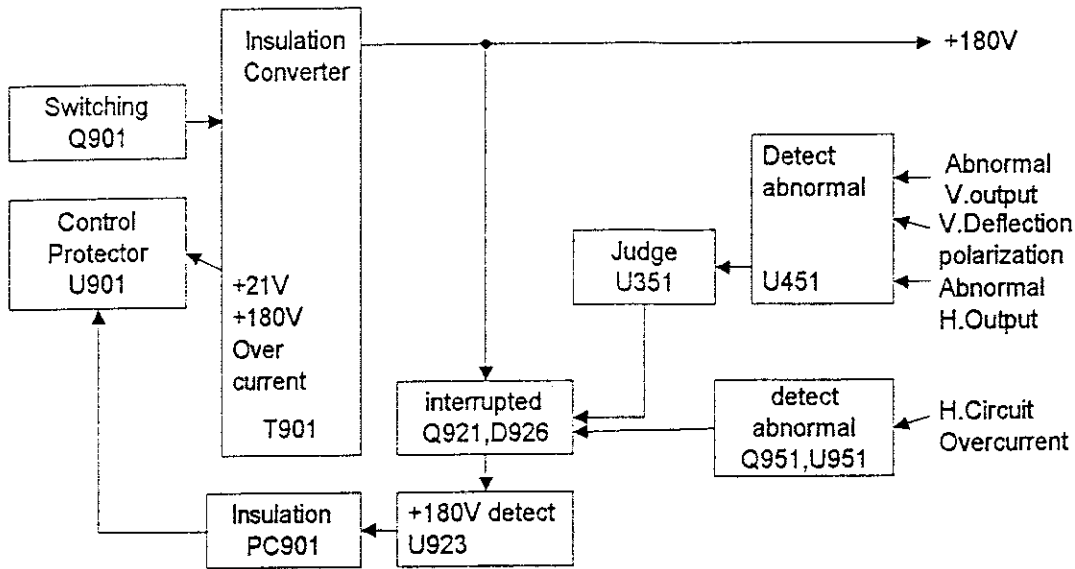

Protection circuit Block

The protection circuit stops the circuit when the monitor is abnormal.

There are 3 detected parts.

- The Q901 over-current protector and over voltage protector by U901.
- The detection of abnormal vertical and horizontal deflection by U451
- The overcorrect detection of horizontal deflection circuit by Q951 and U951.

When the voltage on U901 7 pin exceeds the 4V, the pulse output from 1-pin stops and the power circuit operation stops. The over voltage/current is detected as follows:

- The 180V gets over voltage (about 220V) → The voltage on C910 gets higher. → The D901 conducted → The voltage on U901 7 pin gets 4V. → The pulse on U901 1 pin disappears.
- The over-current (10A peak) runs at Q901. → The R907 detects over-current. → The peak voltage on U901 2 pin gets 0.2V. → The charging current runs to C915 from U901 7 pin. → The voltage on U901 7 pin gets 4V. → The pulse on U901 1 pin disappear.

The U451 detects the following 3 extraordinariness.

- (1): The voltage on U451 5 pin (to detect the extraordinary of vertical output)
- (2): The voltage on U451 3 pin and 6 pin (to detect the polarization for vertical deflection current)
- (3): The voltage on U451 2 pin (to detect the extraordinary for horizontal output)

When they are at normal, the voltages are as (1) > (2) > (3). The output of U451 1 pin and 7 pin are at high level. When the boost voltage disappears at U401 (vertical deflection IC, the voltages are (1) > (2). The output of U451 7 pin gets low level.

When the collector pulse of horizontal output disappears, the voltage gets (3) > (2) and the output of

U451 1pin gets low level

The output from U451 1 pin and 7 pin are input to the U351 27pin (microprocessor). The input stays at low level for 3 seconds, the HIGH is output from 26 pin of U351. Then the Q921 turns on and the 180V get over voltage with turning Q921 ON.

The Q951 detects the over-current of horizontal deflection circuit. When the over-current runs, the Q951 turns ON and charges the C957 connected to the U951 7 pin. When it reaches to 5V, the HIGH voltage output from U951 6pin. Then the Q921 turns on and the 180V get over voltage.

3. Sync Processing, ABL, and Blanking (BLK) circuit

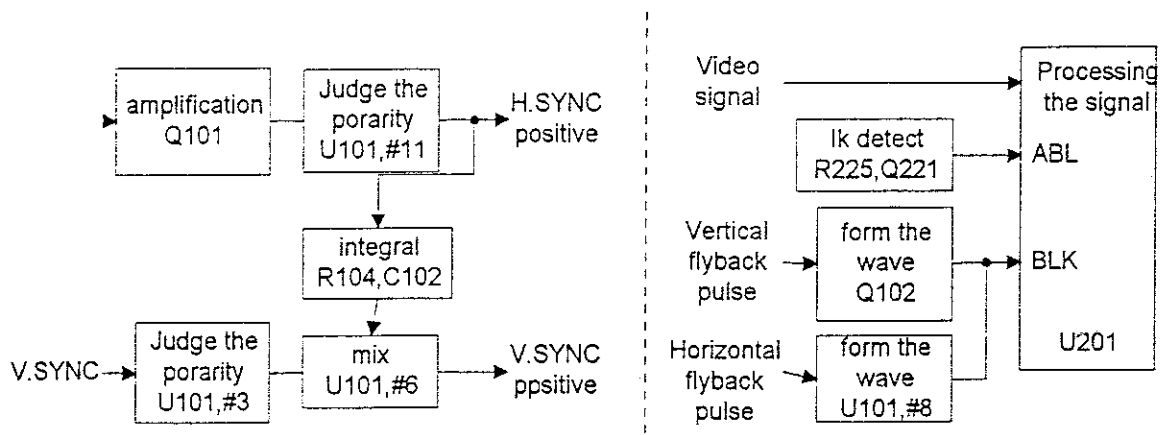

Sync processing, ABL, BLK circuit block

The Sync.processing circuit converts the signal to positive and separate sync. signal to corresponds the composite/separate , positive/negative of the sync.sygnal.

The Q101 amplifies the sync of 5Vp-p.

The U101 12 pin to 11pin and 1 pin to 3 pin judges the polarity and output the positive C/H.Sync to 11 pin and positive V.Sync is output to 3 pin..

At the composite sync input, the V Sync is output from U101 6 pin divided by the integral. At the separate sync input, the V.SYNC same as the input to monitor (converted positive).

The sync signal is send to the U351 (microprocessor) and U601 (deflection IC). It is used to detect the input frequency at U351. At U601, it is used to synchronize the oscillation.

The ABL control the average current of CRT cathode to prevent the over-current to CRT. The current to the CRT runs through R225, R731, T701 8 pin and T701 HV terminal.

It detects the average current to the CRT due to the voltage descent of R225 ($I_k \doteq 1.3\text{mA}$) and controls the voltage on U201 27 pin.

When the voltage on U201 27 pin gets higher, the amplification degree gets smaller. As a result, the contrast gets poor and the average current of CRT cathode is controlled.

The BLK circuit prevents the flying back electron beam luminescent to reflect to phosphor. The BLK pulse is generated by the pulse generated in the fly-back term if horizontal/vertical deflection. The vertical BLK pulse formed at Q102 and horizontal BLK pulse formed at U101 9 pin to 8 pin are mixed and supplied to U201 16 pin. The video signal is blanked in the U201.

4.Horizontal Deflection Circuit

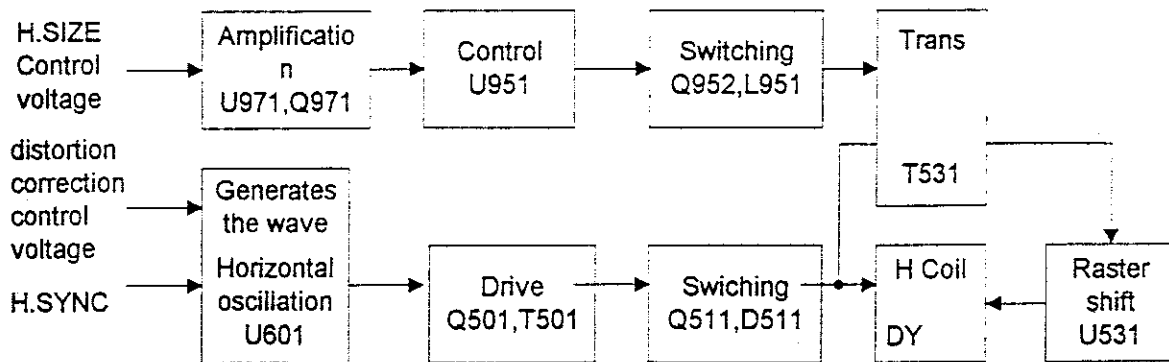

Horizontal Deflection Circuit block

These circuit runs the saw-tooth shape current (about 10Ap-p) at the horizontal coil of DY to scan the CRT electron beams right and left.

The horizontal deflection

The horizontal deflection is performed as follows:

- The U610 18pin outputs the H.Drive pulse. This pulse is synchronized with AFC by the H.Sync input to the U206 26 pin and FBP input to U601 18 pin. The H.Posotion (H.POSI) and parallelogram distortion (PARA) and the balance adjustment (BALANCE) are performed.
- It drives Q511 by converting to current at T501.
- When the Q511 turns on, the current runs to Deflection Yoke increased straightly.
- When the Q511turns OFF, the magnetic energy stored at the deflection Yoke resonant to the capacitor (CS11~CS14). The current inverses with cosine curve.
- The D511 conducts at the inverting the polarity. Then the resonant stops and the straightly increased current runs. By turning on the Q511 again before the current reach to zero, the current continues to increase straightly after the polarity goes back. Thus, the saw-tooth wave runs to the deflection Yoke.

The drive current of Q511 requires adjusting. When the Q511 is replaced the VR501 requires adjustment in order the voltage of CN951 get minimum level at the condition of $f_H=31\text{kHz}$, H.SIZE=MIN.

The Q502 adjusts the drive current according to the H.Size. More current runs to Q502 when the H.Size is enlarged. The RY512 turns On at $f_H=24\text{kHz}$ and $f_H=15\text{kHz}$. The RY513 turns On at $f_H=15\text{kHz}$. Thus the linearity variation is corrected. The U531 adjusts the raster position. When ITC is adjusted due to the CRT or DY replacement, the raster position is changed. Then the R.Shift must be readjust in order the raster comes to the center of the CRT at the condition of $f_H=31\text{kHz}$ and raster appears (by the BRIGHT or SCREEN).

The horizontal size adjustment and raster distortion adjustment.

The H.Size adjustment and raster distortion adjustment is by controlling the horizontal deflection

circuit voltage.

The horizontal size adjustment is performed as follows:

- The U351 (microprocessor) sends to H.SIZE data to U354 (DAC).
- The H.Size voltage runs through U354 5pin, U971 5pin, 7pin and Q971. At the Q971, the current runs proportioned to the voltage on U354 5 pin. The voltage on U971 1pin and U951 12 pin are higher proportioned to the Q971 current.
- The U951 controls the horizontal deflection circuit voltage (the voltage on C953) in order to be proportioned to the voltage on U951 12 pin. This means that the low term of U951 1 pin pulse gets short when the voltage on 11 pin gets high (C953 voltage). Then the ON term of Q952 gets short and the output keeps fixed level with going down the voltage on C953.

The voltage of horizontal deflection circuit is different according to the horizontal frequency and horizontal size. It is about 45 V at $fH=15kHz$, about 70V at $fH=24kHz$ and about 90V at $fH=31kHz$.

The raster distortion correction is performed as follows:

- The data for distortion correction sends to U354 (DAC) from the U351 (microprocessor).
- The U354 send to the control voltage for the CORNER, TRAPE and SPC distortion correction to U601.

The U601 10 pin outputs the each correction mixed wave. The U971 2 pin superimposes to horizontal size adjustment voltage.

5.High Voltage Circuit block

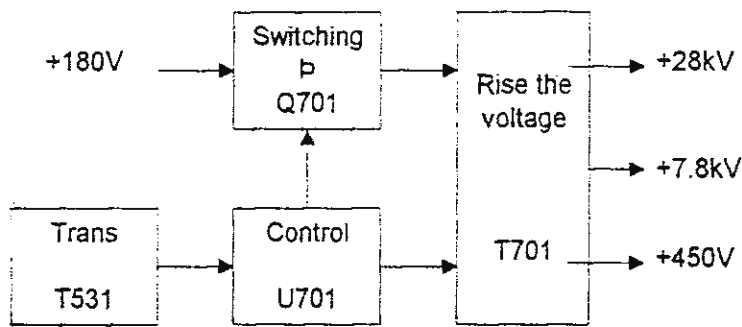

High voltage circuit block

This circuit supplies the high voltage to the each electrode for the operation of the CRT. This circuit supplies 28 kV to the CRT anode, 7.8 kV to focus electrode and about 450V to the G2 electrode. When the pulse (about 10Vp-p) is input to the U701 4pin from the horizontal deflection circuit, the triggered pulse is output from U701 1pin and the high voltage circuit operates.

The high voltage is stabilized as follows:

- The voltage parted from high voltage is inputs to U701 6 pin from T701 11pin.
- The drive pulse is output from the U701 1pin. When the input voltage to 6 pin (high voltage) gets high level, the ON term gets short.
- Then, the energy stored at T701 is decreased and the high voltage is gone down. Thus, the high voltage keeps its level.

The X-ray protection is performed as follows:

- This circuit gets the voltage proportioned to the high voltage from the tertiary winding voltage of T701 (FBT).
- The protector operates when the voltage on U701 10 pin becomes 2.35V.
- The voltage on C711 is 24.05 V when the high voltage is 31.5kV. In order to the protector operation of such case, the VR711 has been adjusted and locked with silicone.

6. Vertical Deflection Circuit

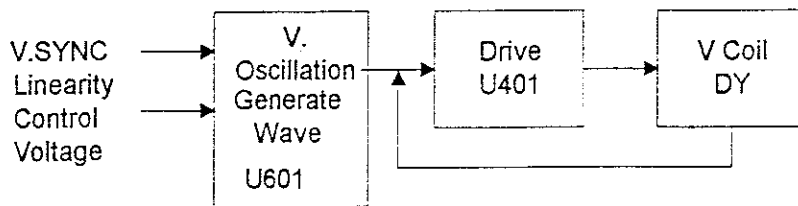

Vertical Deflection Circuit Block

This circuit runs the saw-tooth shape current (about 1.8Ap-p) to the V.Coil of the DY in order to scan the electron beam vertically.

The saw-tooth voltage (about 2Vp-p) is output from U601 9 pin, which is triggered by the V.SYNC pulse.

The linearity correction signal (V.L.S and V.L.C) transmits to the U601 (deflection IC) through the U351 (microprocessor) and U354 (DAC). It is output from U601 9pin superimposed to the saw-tooth voltage.

The U401 operates as the ope-amp. (The +input is U401 5 pin, the - input is U401 6 pin). This means that the output from U401 3 pin varies so that the wave output from U601 9 pin and the wave converted by the R408 from the current run at DY.

7.Video Amplified Circuit

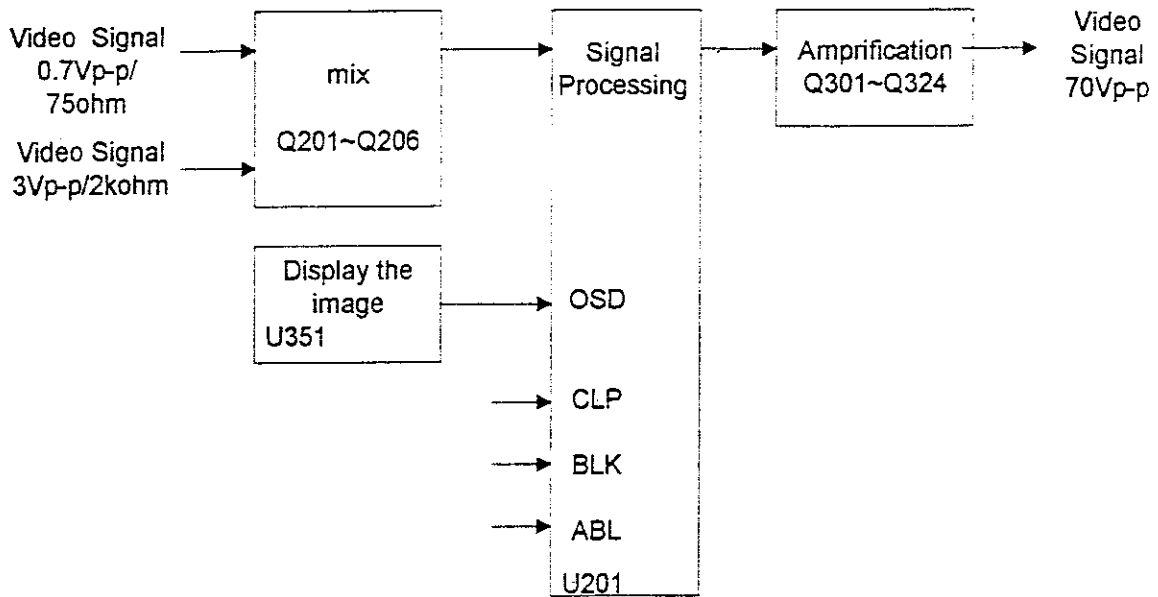

Video Amplified Block

This circuit amplifies 0.7V_{p-p}/3V_{p-p}-input signal to about 70V_{p-p} to gain the sufficient contrast. The input signal 0.7V_{p-p}/75 Ω or 3V_{p-p}/2k Ω are united to 0.65 V_{p-p} amplitude at the mix circuit(Q201~Q206) and supplied to U201.

The U201 treat the amplification, direct-current restoration, switching the OSD signal, Brightness adjustment, contrast adjustment, ABL adjustment and blanking addition. The signal transmitted to PCB-CRT (about 1.6 V_{p-p}) amplified to about 70V_{p-p} at Q301~Q324 and supplied to CRT cathode.

III Adjustments and Control

Do not touch any other volumes than the below volumes if not necessary.

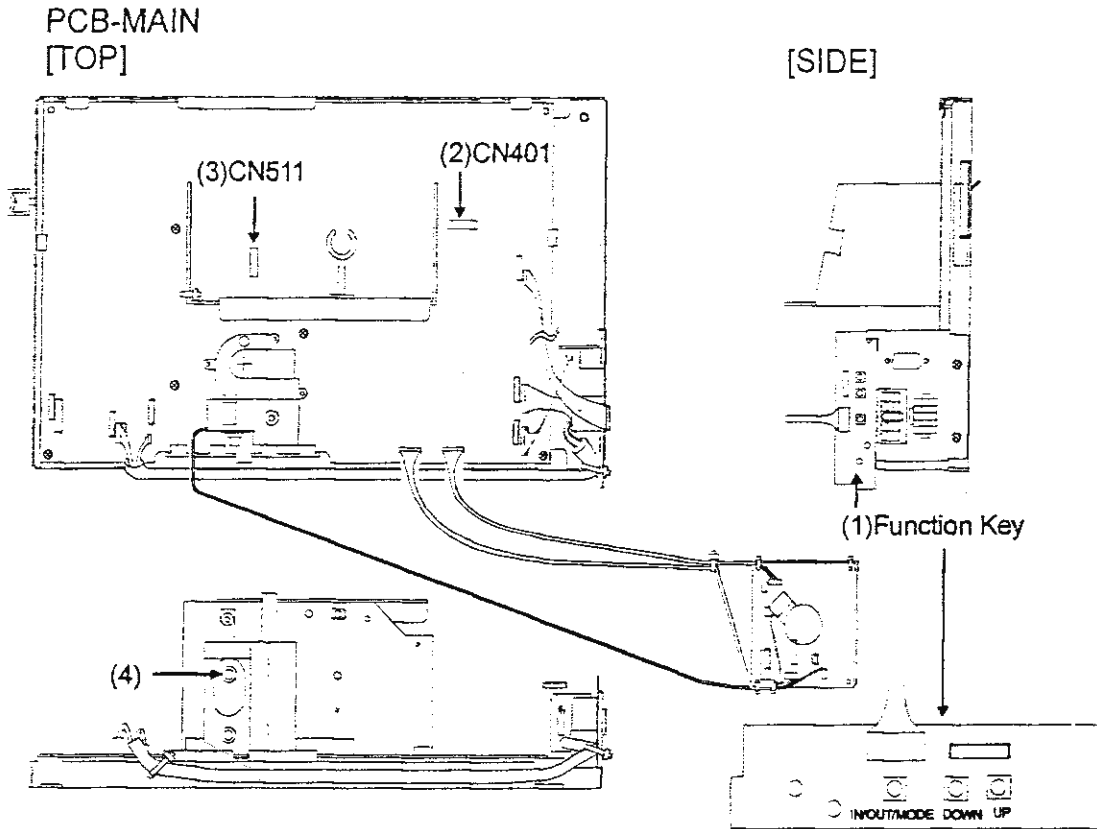

- 1 **Name**
 - (1) Function Key: Display the OSD for screen adjustment
 - (2) The connector to switch the polarity of Deflection Yoke [CN401]
 - (3) The connector to switch the polarity of Deflection Yoke [CN511]
 - (4) FOCUS: Adjusts the focus

2 Adjustment by OSD (On Screen Display)

Use the Function Key (1) (MODE/UP/DOWN button)

● Operation

1. Pressing the MODE button displays the OSD (the right side number indicates input frequency)

Ex) 31kHz input

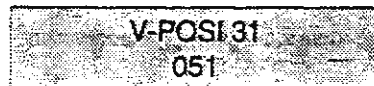

<OSD>

2. Press MODE button and select the adjustment menu.
 (Whenever the MODE button presses, the OSD changes as V-POSI→H-POSI→V.SIZE→H-SIZE
 →CONTRAST→BRIGHT→DEGAUSS→RESET→OSD menu OFF)

<Note>

Press the MODE button and DOWN button at same time, the adjustment menu returns to previous menu.

4. Adjust with UP/DOWN buttons.
5. To hide the OSD, repeat pressing the MODE button until the menu is OFF.

- Adjustment Menu

- V-POSI
Adjust the vertical position of image.
- H-POSI
Adjust the horizontal position of image.
- V-SIZE
Adjust the vertical dimension of the image.
- H-SIZE
Adjust the horizontal dimension of the image.
- CONTRAST
Adjust the contrast of the image.
- BRIGHT
Adjust the brightness of the image.
- DEGAUSS
Perform the degauss.
Once degaussing, this function does not work for about 5 minutes. (Please wait until the lower OSD indicates <PLEASE> for the next degauss)
- RESET
The adjustments return to default setting. (Press the UP or DOWN button for a few seconds)

V-POSI



H-POSI

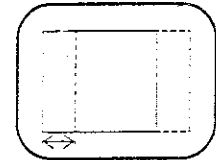

V-SIZE

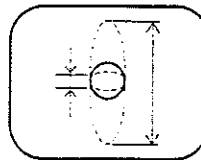

H-SIZE

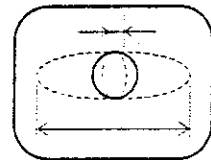





- Store the adjustment data

The proper image is automatically displayed to the 3 type input signal (H.Frequency: 15kHz Mode, 24kHz Mode, 31kHz Mode) as the factory setting. In addition, the user can store the 1 adjustment status to microprocessor in each mode. Therefore, the adjustment once made does not require further adjustment. To return the default setting, perform the <RESET> function at the OSD.

3 Other adjustment

- (2), (3) Switch the polarity of the Deflection Yoke

	CN401 (2) (NORMAL)	④CN401 (2) (REVERSE)
CN511 (3) normal connection	 Normal Screen	 Reversed Screen
CN511 (3) reverse connection	 Mirrored	 180° rotated screen

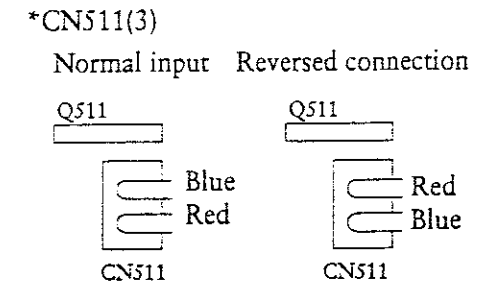
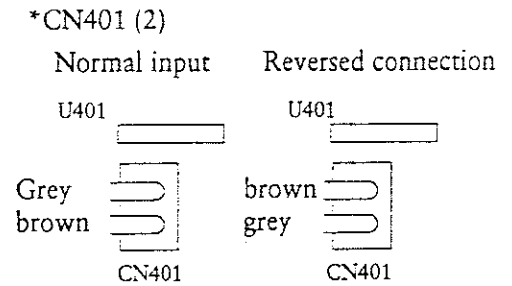

- (4) FOCUS
Adjust to get best focus.

4 Special Function

- Auto Switching function the display mode

This model judges the input frequency automatically (H.frequency: 15kHz Mode, 24kHz Mode, 31 kHz Mode) and display the image.

IV Adjustments

1. Factory Adjustments

The factory adjustment uses the OSD appears by pressing the buttons connected to AMP-UP connector through the build-in microprocessor. Enter the factory mode for the factory adjustment.

1-1. Factory adjustment Mode

- (1) To enter the factory mode, press the 3 buttons (MODE, UP, DOWN) at a same time (for 3 seconds) in the normal operation (Without OSD). Press the UP and DOWN button first and then press the MODE button,
- (2) Whenever the MODE button pressed, the adjustment menu changes. To select the adjustment menu in the reversed order, press the DOWN button with pressing the MODE switch.

Please note that the adjustment menu changes continuously by pressing the MODE switch continuously.

- (3) To change the data press the UP/DOWN button in each mode.
- (4) After the adjustment, store the adjustment data in each frequency mode by SAVE.
- (5) Return to Normal mode to end the factory mode. Press the MODE button until the OSD indicates "EXIT". Press the UP or DOWN button for a few seconds to return the normal mode

1-2. Factory adjustment menu

No.	menu	adjustment
1	FH0	horizontal sync check (Free run adjustment)
2	FH0-FINE	Horizontal sync. check (Free run adjustment)
3	R-SHIFT	Horizontal raster adjustment
4	V-LIN-S	Vertical linearity adjustment
5	V-LIN-C	Vertical linearity adjustment
6	V-POSI	Vertical position adjustment
7	H-POSI	Horizontal position adjustment
8	V-LIMIT	Vertical Size Limit adjustment
9	H-LIMIT	Horizontal Size Limit adjustment
10	V-SIZE	Vertical Width adjustment
11	H-SIZE	Horizontal Width adjustment
12	TRAPE	Trapezoidal distortion adjustment
13	PARA	Parallelogram distortion adjustment
14	BALANCE	Side-pin Balance distortion adjustment

No.	menu	adjustment
15	SPC	Side-pin cushion distortion adjustment
16	CORNER	Top/bottom corner distortion adjustment
17	R-CUTOFF	White balance adjustment for dark area
18	G-CUTOFF	White balance adjustment for dark area
19	B-CUTOFF	White balance adjustment for dark area
20	R-GAIN	White balance adjustment for bright area
21	G-GAIN	White balance adjustment for bright area
22	B-GAIN	White balance adjustment for bright area
23	ABL	ABL adjustment
24	C-CENTER	Center brightness adjustment
25	CONTRAST	Do not use. The contrast must be adjusted by C-CENTER
26	BRIGHT	Adjust the brightness
27	COLORCOPY	Store the adjustment data (Copy the adjustment data for R,G and B CUTOFF, R,G and B GAIN, ABL, C-CENTER and BRIGHT to each frequency mode)
28	DEGAUSS	Degaussing
29	SAVE	Store the adjustment data in each frequency mode
30	RESET	Return to the default setting
31	VERSION	Display the version of OSD
32	EXIT	Exit the factory mode

2. General Adjustment

Before starting the general adjustment, the following tools are recommended to do below tuning

- Degaussing Bar
- Electrostatic voltmeter
- Frequency Counter
- Signal generator which has same timing as the standard signal with 0.7Vp-p output, window pattern and white filed pattern
- Brightness meter
- DC Power Supply (more than 25V)
- Diode (Code Number : 00J25833A1, Description:1SS133)

2-1. Signal

ROM No.	No.	Name	Mode	H/V	Frequency	Dotclock	Total	Sync	B.P	Video	Sync polarity	Video Level
1	A	Sega ST-V	15k	H[μ s]	15.75kHz	14.32MHz	63.56	4.75	6.45	49.17	Comp	3.0Vp-p
				V[H]	59.82Hz		263	3	23	224	Nega	2k Ω
2	B	Sega Model3 (24k)	24k	H[μ s]	24.39kHz	16.00MHz	41.00	3.00	4.44	30.69	Comp	0.7Vp-p
				V[H]	57.52Hz		424	4	28	381	Nega	75 Ω
3	C	Sega Model3 (31k)	31k	H[μ s]	31.67kHz	24.57MHz	31.58	3.58	1.75	23.92	Comp	0.7Vp-p
				V[H]	60.32Hz		525	2	36	477	Nega	75 Ω
4	D	Size Limit 15k	15k	H[μ s]	15.75kHz	14.32MHz	63.56	4.75	7.90	46.00	Comp	0.7Vp-p
				V[H]	59.82Hz		263	3	35	199	Nega	75 Ω
5	E	Size Limit 24k	24k	H[μ s]	24.39kHz	16.00MHz	41.00	3.00	5.54	28.40	Comp	0.7Vp-p
				V[H]	57.52Hz		424	4	40	354	Nega	75 Ω
6	F	Size Limit 31k	31k	H[μ s]	31.67kHz	24.57MHz	31.58	3.58	2.85	23.76	Comp	0.7Vp-p
				V[H]	60.32Hz		525	2	44	457	Nega	75 Ω

2-2. Preset

Each adjustment volume must be preset at the following location before powering on except the case it has been adjusted.

No.	PCB	Symbol	name	Preset
1	MAIN	VR921	+B-ADI	Center
2	↑	VR721	HV-ADI	↑
3	↑	VR711	X-PRO	Clockwise. Max
4	↑	VR501	H-DRIVE	Counter-Clockwise.
5	↑	T701 (FBT)	SCREEN	↑
6	↑	T701 (FBT)	FOCUS	Center

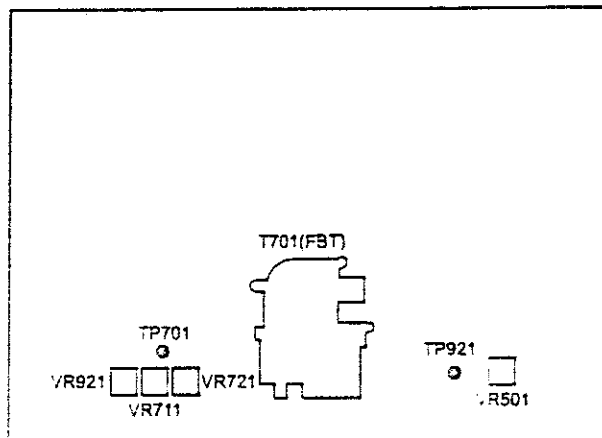

<PCB-MAIN---Parts Side>

2-3. Before the adjustment

- Use the signal No.C (Rom No.3) Model 3 (31.6kHz) signal as the standard signal, unless otherwise specified.
- Input voltage should be 100 VAC.
- Connect the GND terminal to the chassis base or the radiator at the center of the PCB-MAIN.
- The CRT and the base should be degaussed.
- Make the pre-heat more than 30 minutes.
- The brightness in heat-running should be set 7 ft-L approx.
- The screen should face the east at adjusting, unless otherwise specified.
- The magnetic field should be set at the Japanese level ($B_v = 0.35G$, $B_H = 0.3G$)

2-4. Adjustments

 **WARNING**

Do not short any position of the circuit while the monitor is in operation.

This will cause smoke, electric shock or damage to transistors, ICs or other parts or circuit in the unit. (Excluding the adjustment only when specified).

Be sure to save in each frequency mode in the adjustment by OSD

(indicated with  icon)

A. +B. adjustments No signal

Use the +B-ADJ (VR921), adjust to get $180 \pm 0.2VDC$ at the voltage on TP921.

B. Preset Cross-hatch

Turn the SCREEN VR slowly.

Adjust the SCREEN VR on the FBT so that the back-raster slightly appears. Adjust the FOCUS VR on the FBT to get the best-focused image.

C. Input connector check Signal No. A, B

Switch the input connector and check there are no extraordinary on the screen image.

Video Input Mode	Input connector
Hi : Video 2k Ω termination (EH-6P(AMP 15P) input)	CN201
Lo : Video 75k Ω termination (D-SUB MINI 15P input)	CN251

D. H.Sync. check No signal OSD

(1) Set the probe of the frequency counter at the DY red lead. Confirm that the free-run frequency shows the following values

(Once input the signal and remove the signal wire, the signal mode is available)

(1) 15kHz Mode $15.75 \pm 0.1\text{kHz}$

(2) 24kHz Mode $24.40 \pm 0.1\text{kHz}$

(3) 31kHz Mode $31.50 \pm 0.1\text{kHz}$

(2) If they are not in the above range, readjust by fH0 or fH0-FINE at the factory mode.

Please note that, the value of fH0-FINE shows at 128 (middle range) after the adjustment with "fH0".

*Auto adjustment free-run frequency

Press the UP and DOWN button at same time for about 3 seconds with no signal input, the free-run frequency is automatically adjusted in every mode. (For about 15 seconds. requires)

Do not input any signal at the auto adjustment. Otherwise, the adjustment is stopped. (If any signal is input, the OSD shows "FREERUN AGAIN" for 3 seconds.)

E. High Voltage adjustment Cross-hatch Safety important adjustment

(1) Connect the electrostatic voltmeter at CRT anode.

(2) With HV-ADJ (VR721), adjust the high voltage to get $28.0 \pm 0.2\text{kV}$.

(3) After the adjustment seal the HV-ADJ (VR721) with silicone.

F. X ray protector adjustment Cross-hatch Safety important adjustment

(1) Check the voltage on TP701 shows $21.0 \pm 2.0\text{V}$ with the X-PRO (VR711).

(2) Impress $24.05 \pm 0.05\text{V}$ to the TP701 from the DC power supply through the diode (1SS133) to protect DC Power supply. The minus terminal of DC Power supply shall be connected to the chassis ground (GND). (Use the DC Power supply of over 0.5A current capacity.) Turn the X-PRO (VR711) slowly and stops at the position the screen disappears (the high voltage stops)

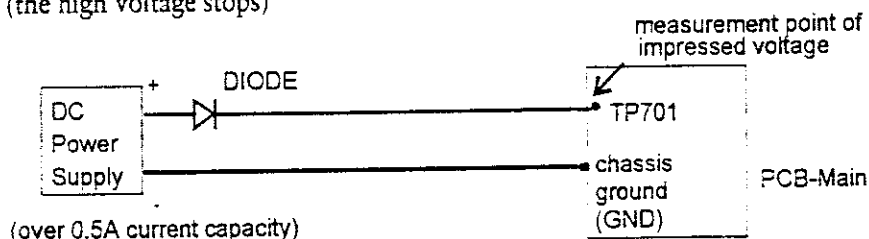
G. X ray protector confirmation Cross-hatch Safety important adjustment

(1) Confirm that there is no protector operation when you impress the 23.95V to TP701 from the DC power supply through the diode. (Refer to the figure above)

(2) After the confirmation, seal the X-PRO (VR711) with silicone rubber

H. H drive adjustment (VR501) Cross-hatch

Adjust the VR501 to get the minimum voltage between the terminals of CN951 with the minimum H.Size. Seal the VR501 with the silicone rubber after the adjustment.

Use an extension connector when making adjustment.

I. Screen adjustment (SCREEN) black field OSD

(1) Go into factory mode

(2) Select "BRIGHT" and maximize the value.

(3) Adjust the SCREEN VR (T701) to get 0.8 ± 0.1 ft-L.

(4) Adjust the white balance with "R, B-CUTOFF"

$$X : 0.285 \pm 0.015$$

$$Y : 0.285 \pm 0.015$$

(5) Repeat the (3) and (4) steps, if necessary.

(6) After the adjustment, disappear the back-raster by using "BRIGHT"

(7) After the adjustment, perform the "COLOR COPY" and copy the data to the each mode. (Press the UP or DOWN button for a few seconds, the OSD shows "ON" and the "COLOR COPY" is performed.)

Do not touch SCREEN VR after the adjustment.

J. Focus adjustment Cross-hatch

Adjust with FOCUS VR on the FBT to get the best focus in the right part (see the figure)

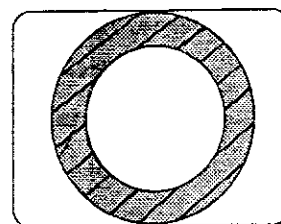

K. Degauss circuit confirmation white field OSD

Confirm that the screen is degaussed with the power ON or "DEGAUSS" of OSD with the magnetized set.

L. H. position adjustment black field OSD

(1) Get into factory mode.

(2) Maximize the "BRIGHT" and set the "H.SIZE" to get under-scanned image.

(3) Adjust by using "R-SHIFT" to center the back-raster horizontally.

(The length from raster to bezel is within 1mm)

M. V.Linearity adjustment Signal No. A, B, C, Cross-hatch OSD

- (1) Get into factory mode.
- (2) Center the image vertically by using "V-POSI".
- (3) Adjust by using "V-LIN-S" and "V-LIN-C" to get the same width the crosshatch pattern at top and bottom. (Refer to below)

V-LIN-S (The top and bottom heights varies at the same time)

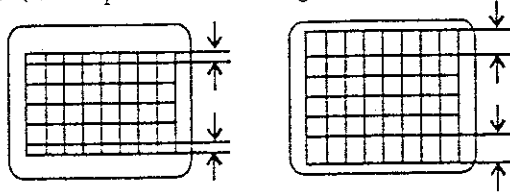

V-LIN-C (Lower the top height, the bottom height is widened. Same as the opposite)

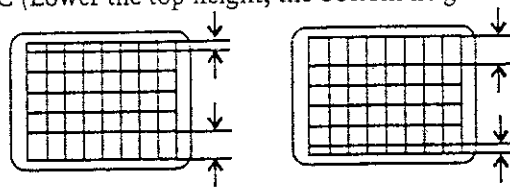
N. Distortion correction Signal No. A, B, C, Cross-hatch OSD

Get into the factory mode and perform the necessary distortion adjustment.

TRAPE: Trapezoidal distortion

PARA: parallelogram distortion

BALANCE: Side-Pin Balance distortion

SPC: Side-pin cushion distortion

CORNER: Top/bottom corner distortion

O. Size/position adjustment Signal No. A, B, C, Cross-hatch OSD

- (1) Get into the factory mode.
- (2) Adjust the Size and position to get the same size of the edge between the image and the CRT Screen by using "H-SIZE", "V-SIZE", "H-POSI" and V-POSI. (The length from raster to bezel is $5 \pm 3\text{mm}$)

P. H.V Size Limit adjustment Signal No. D, E, F, Cross-hatch OSD

- (1) Get into the factory mode.
- (2) Adjust the Size by using "V-LIMIT" and "H-LIMIT" so that the length from raster to the bezel is equal at top/bottom/right/left corner (The length from raster to bezel is $0 \pm 3\text{mm}$)

- Q. White balance adjustment for dark area Signal No. A, B, C, Black field OSD
- (1) Get into the factory mode.
 - (2) Maximize the "BRIGHT" value.
 - (3) Adjust the white balance of dark area by using "R-CUTOFF" and "B-CUTOFF"
 - $\chi : 0.285 \pm 0.010$
 - $Y : 0.285 \pm 0.010$
- R. BRIGHT adjustment Signal No. A, B, C, black-field OSD
- (1) Get into the factory adjustment.
 - (2) Select the "BRIGHT" and adjust at the position the back-raster disappears.
- S. Center brightness adjustment Signal No. A, B, C Window OSD
- (1) Get into the factory mode.
 - (2) Adjust by using "C-CENTER" to get the 60 ± 2 ft-L of white window center brightness
-
- Use the "C-CENTER" only the center brightness adjustment.
-
- T. White balances adjustment for bright area signal No. A, B, C OSD
- (1) Get into the factory mode.
 - (2) Adjust the white balance for bright area by using "R-GAIN" and "B-GAIN".
 - $\chi : 0.285 \pm 0.010$
 - $Y : 0.285 \pm 0.010$
 - (3) If necessary, repeat the center bright brightness adjustment and white balance adjustment for bright area.
- U. ABL Adjustment Signal No. A, B, C, white-field OSD
- (1) Get into the factory adjustment mode.
 - (2) Adjust by using "ABL" to get the 30 ± 1 ft-L of white filed brightness.
- V. ITC Adjustment
- V-1 Magnetic field
- Japanese level. Face the screen the east.
- V-2 Preset of the static convergence
- Using the degaussing bar, rhtoughly degauss and perform the static convergence adjustment roughly according to the V-4.

V-3 landing adjustment Red field

- (1) Shift the deflection Yoke ahead and rearward to get the best position.
- (2) Hold the deflection Yoke to the CRT funnel (draw forward) and adjust so that the red zone centers horizontally by using 2P magnet.
- (3) Shift the deflection Yoke backward at the position that the entire screen gets red. Fasten with screw with care of the rotation of the screen. Then, fix the deflection Yoke with wedge so that the oscillation of the deflection Yoke centers up/down/right/left. Adjust with blue and green raster. If necessary, perform the fine control.
- (4) Confirm that white uniformity is favorable at the white raster. Rotate the screen to face all direction and confirm that conspicuous different colors shall not recognizable. If any, correct by using the magnet (08R50047A1) on the CRT funnel. After the adjustment, seal it with the silicone rubber (08F08087A1)

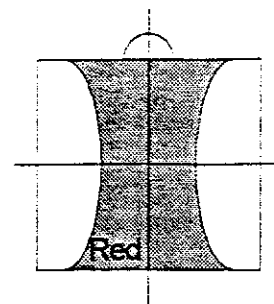

V-4 Static convergence

- (1) Receive the cross-hatch signal and adjust to get the best focus.
- (2) Receive the magenta cross-hatch signal and adjust the 4P magnet to align the Red/Blue cross hatch lines exactly one on top of another.
Rotation of the magnet (two magnets)—shifts the direction of two colors
Opening the magnet — shifts the distance between the two
- (3) Receive white cross-hatch signal. Rotate and adjust the 6P magnet to align the GREEN and MAGENDA cross-hatch lines exactly one on top of another.
Rotation of the magnet (two magnets)—shifts the direction of two colors
Opening the magnet — shifts the distance between the two
(The green pattern will remain stationary)
- (4) Repeat above step (2) and (3), if necessary.

V-5 Dynamic convergence

- (1) Receive the magenta cross-hatch signal and adjust the mis-convergece.
- (2) Move the DY top/downward and adjust the mis-convergence.

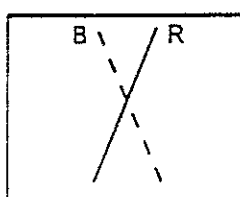

bottom

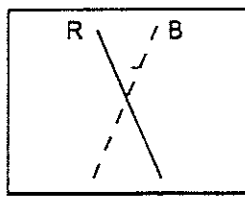

top

- (3) Shift the DY right or left and adjust to minimize the mis-convergence of each corner.

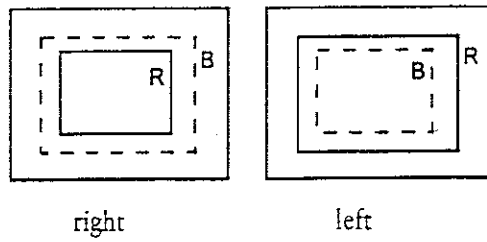

- (4) Insert the wedge (08N46012A1) as follows and seal with silicon rubber (00F08221A1)

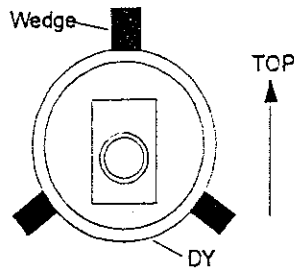

- (5) Adjust the Yv by using magnet. (09F50363A1 or 09F50364A1) and seal with silicon rubber(08F08087A1)

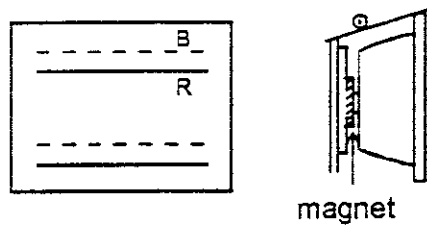

- (6) Adjust the Xv by the differential coil.

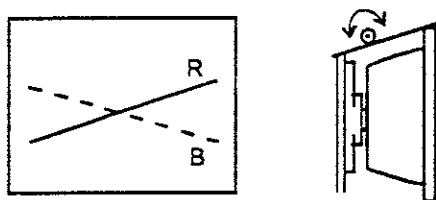

- (7) If necessary, insert the ferrite sheet (08F50377A1) between the DY to CRT and adjust the mis-convergence of each corner area. After adjustment, seal with silicon rubber (08F08087A1)

V-6 Seal

- by YUKI Racker<yellow> (09F08139A1) at CP magnet, Screens on the DY, paint lock
- by silicone rubber (00F08221A1) <KE45RTV> at Wedge.

V troubleshooting

⚠ WARNING



When checking wave on the primary line, use the 2 pin power plug of oscilloscope.
Do not connect GND on the primary circuit and GND on the secondary circuit. (chassis)
If not, this may cause electric shock, damage to the circuit or breaker down.

⚠ WARNING



Do not check wave on the primary and secondary voltage line with same oscilloscope at same time. If necessary, connect the Isolation Trans for the power of monitor. This may cause an electric shock or damage to the circuit.

Please refer to the circuit Description section

1. No Display

1-1. CRT heater does not light and the high voltage does not come

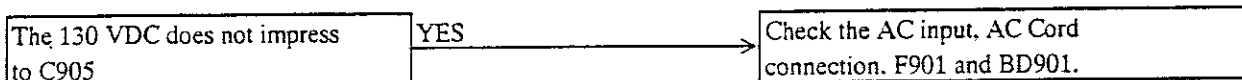

⚠ WARNING



Handle the C905 with care to the electric shock or insulation because this is primary parts.

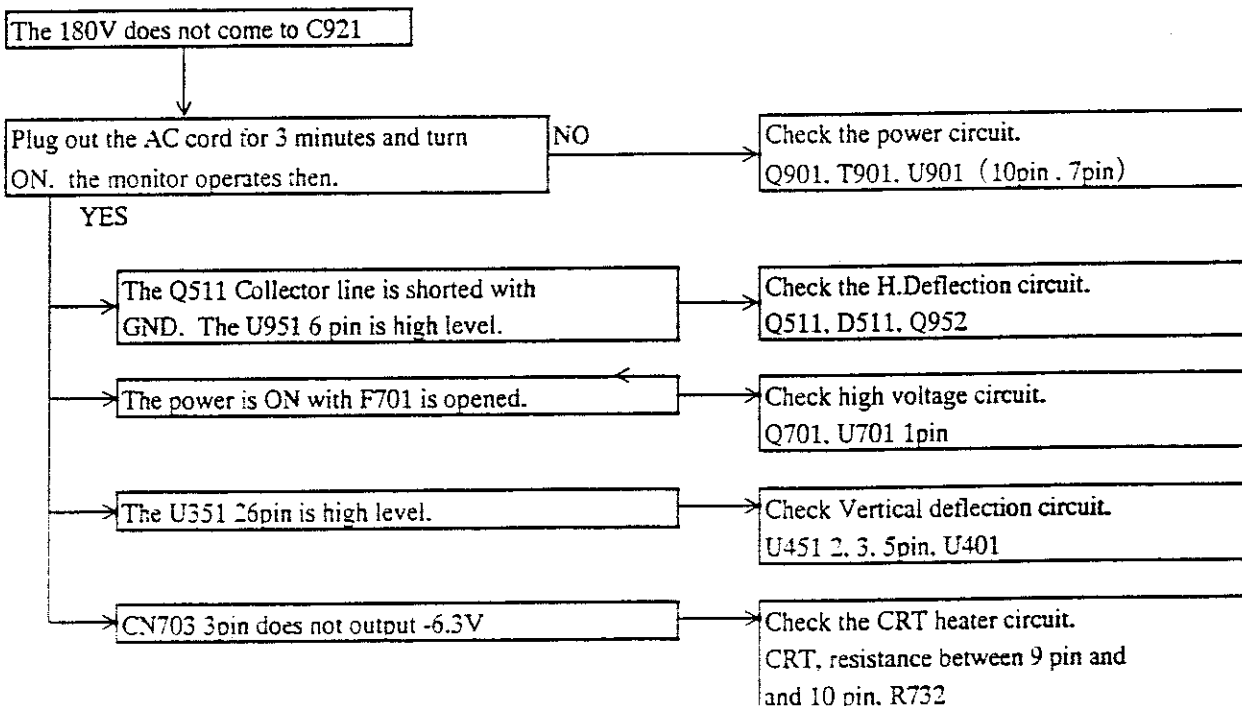

1-2. The CRT heater lights but no high voltage sound

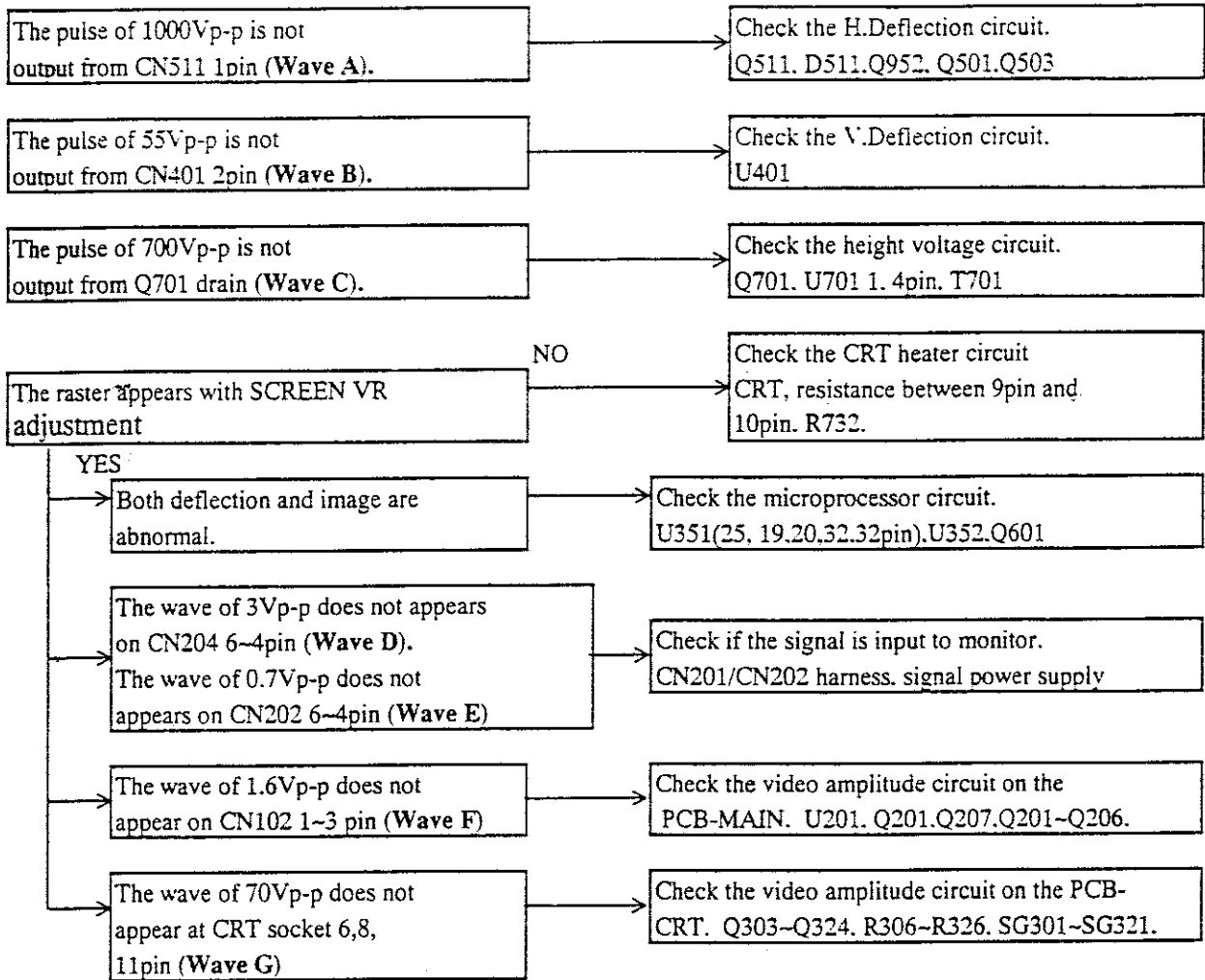

Wave A

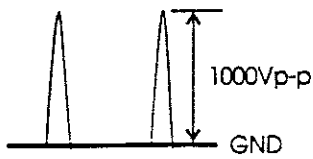

Wave B

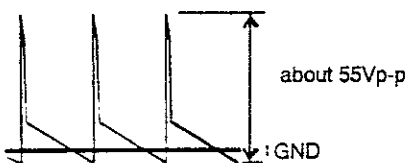

Wave C

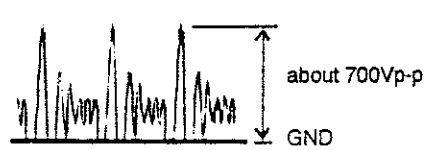

Wave D



Wave E



Wave F



Wave G



2. Sync is not correct

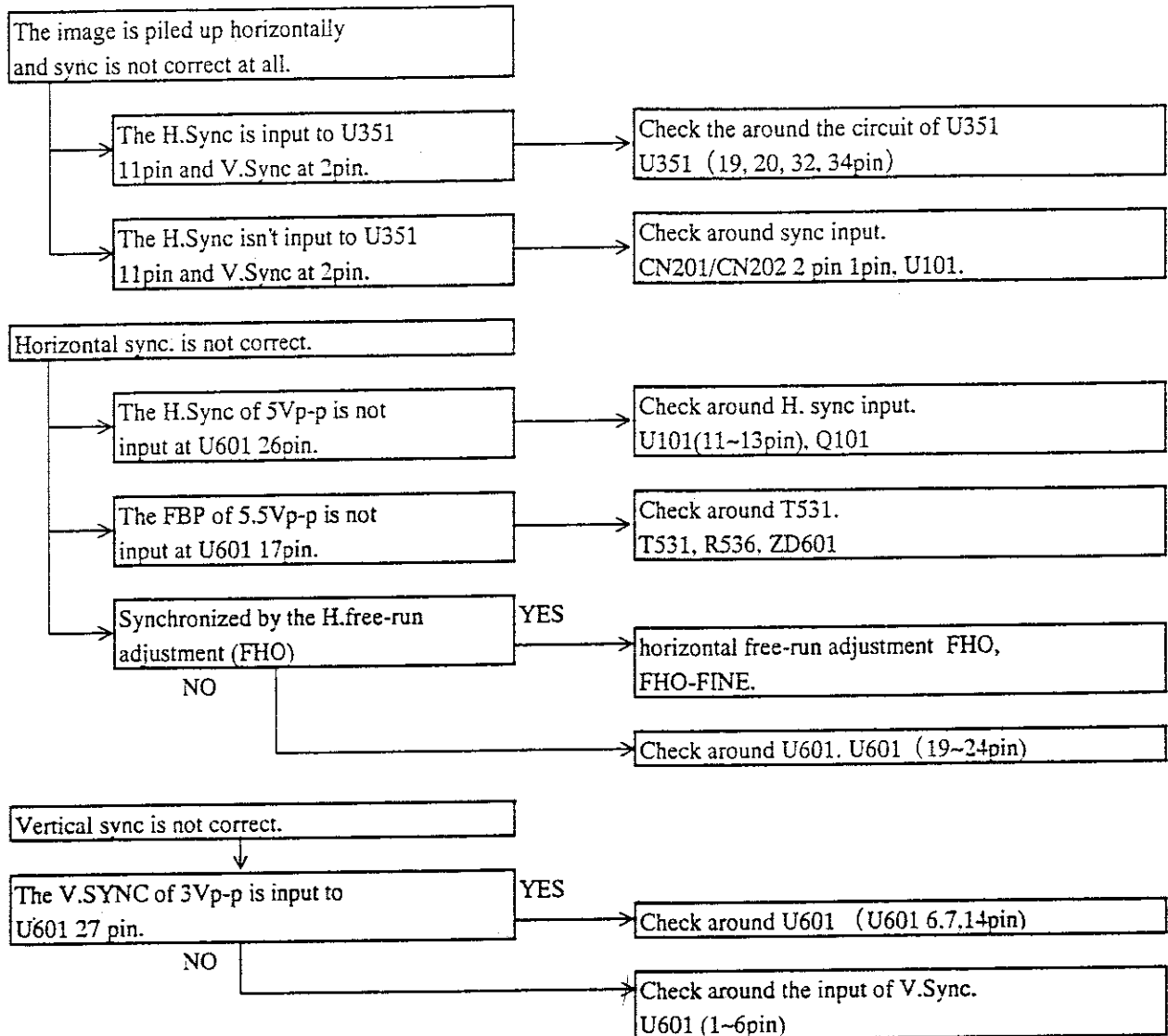

3. The image is too dark

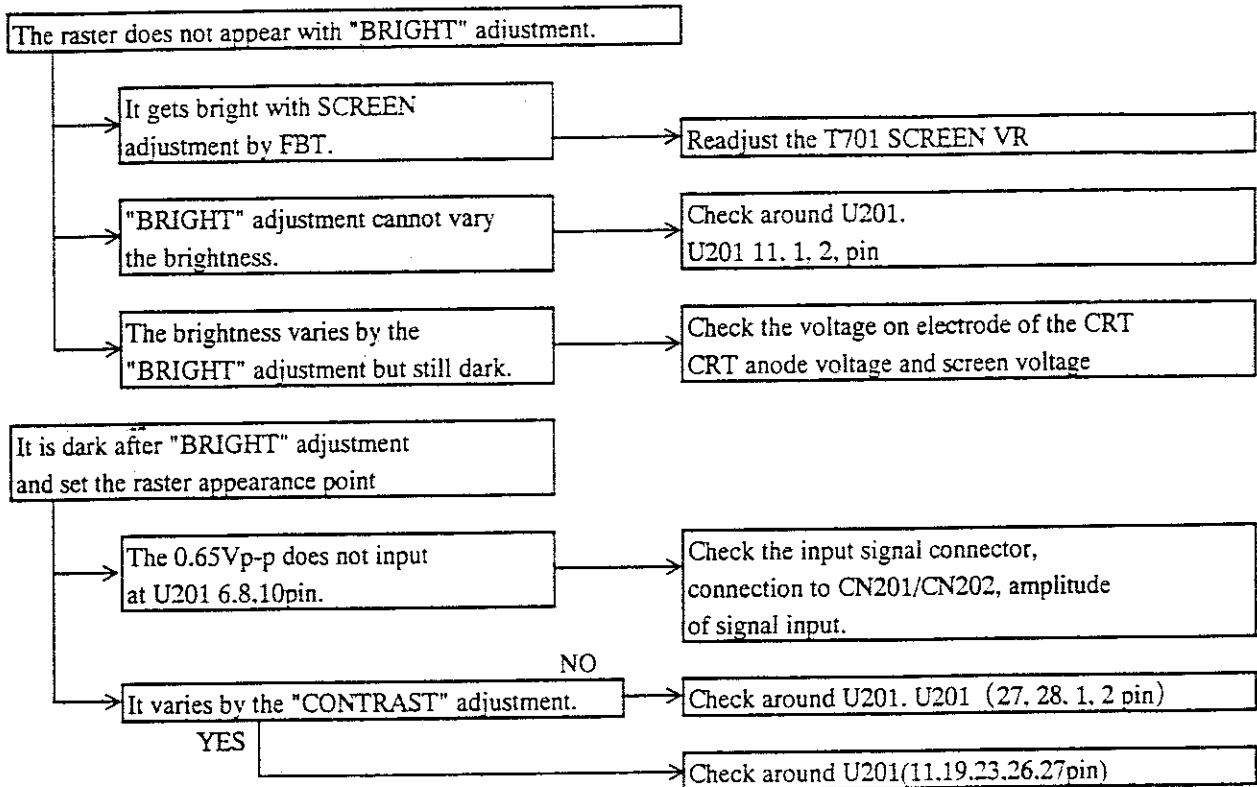

4. Poor Focus

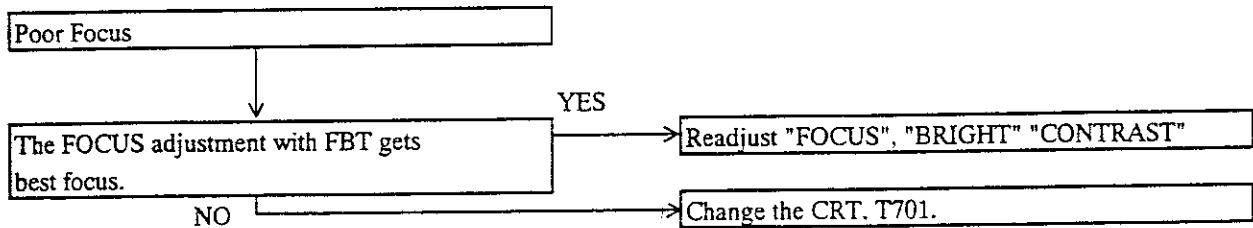

5. The adjustment data can not save



6. The H.linearity is bad in the H.frequency mode.

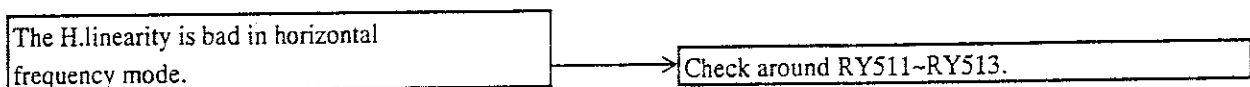

7. The image is tilted rightward/leftward

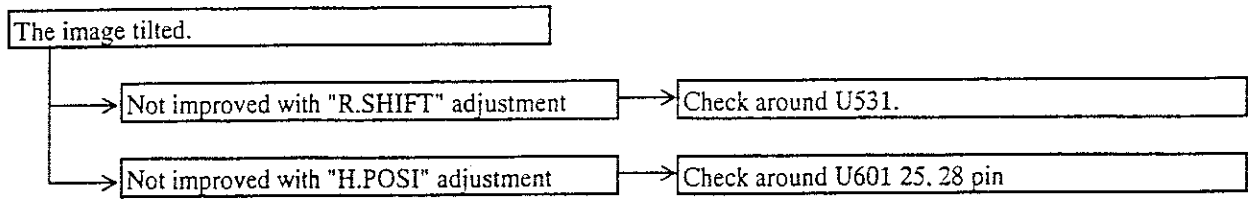

8. Degauss does not work.



9. Spot remains

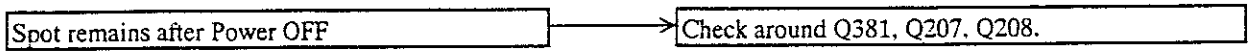

SECTION VI : APPENDICES

1. Parts List for MS-2931

A Mark: Antistatic Parts
 M Mark: Moisture Protection parts
 S Mark: Safety related parts
 X Mark: X-ray radiation related parts
 OR: Substitute for the parts above

Contents

1	ASS'Y CHASSIS UNIT	Page 2
	ASS'Y PCB MAIN	Page 2
	ASS'Y PCB CRT	Page 12
	OTHERS	Page 13
2	OTHERS	Page 14
3	ASSEMBLED PARTS	Page 14

2. Electric Diagram

- * CONNECTION DIAGRAM
- * SCHEMATIC DIAGRAM for PCB-MAIN
- * SCHEMATIC DIAGRAM for PCB-CRT

A	M	S	X	SYMB.	CODE	NAME	DESCRIPTION	QTY
1. ASS'Y CHASSIS UNIT								
**** ASS'Y PCB MAIN ****								
S				BD901	00N25197A4	D-BRIDGE	RBV-606	1
				C101	0EK90105ZF	CP-C-CERAMIC	GRM40 16V F 105Z PT	1
				C102	0KP04102KB	CP-C-CERAMIC	GRM39 50V B 102K PT	1
				C103	0EK90105ZF	CP-C-CERAMIC	GRM40 16V F 105Z PT	1
				C104	0ET91470MT	C-EL	YXA 16V 47MF-M TP 5X11	1
				C105	0KP04103ZF	CP-C-CERAMIC	GRM39 50V F 103Z PT	1
				C106	0EK90105ZF	CP-C-CERAMIC	GRM40 16V F 105Z PT	1
				C107	0KP03471JC	CP-C-CERAMIC	GRM39 50V CH 471J PT	1
				C108	0KP03471JC	CP-C-CERAMIC	GRM39 50V CH 471J PT	1
				C109	0GP04104ZF	CP-C-CERAMIC	GRM39 25V F 104Z PT	1
				C110	0GP04104ZF	CP-C-CERAMIC	GRM39 25V F 104Z PT	1
				C111	0KK86332JM	CP-C-CERAMIC	GRM40 50V SL 332J PT	1
				C112	0KP04472KB	CP-C-CERAMIC	GRM39 50V B 472K PT	1
				C201	0KT91100MT	C-EL	YXA 50V 10MF-M TP 5X11	1
				C202	0EP88470MW	C-EL	KMA 16V 47MF-M TP 6.3X7	1
				C203	0EP88101MW	C-EL	KMA 16V 100MF-M TP 7X7	1
				C221	0GP04104ZF	CP-C-CERAMIC	GRM39 25V F 104Z PT	1
				C222	0GP04104ZF	CP-C-CERAMIC	GRM39 25V F 104Z PT	1
				C223	0GP04104ZF	CP-C-CERAMIC	GRM39 25V F 104Z PT	1
				C224	0GP04104ZF	CP-C-CERAMIC	GRM39 25V F 104Z PT	1
				C225	0GP04104ZF	CP-C-CERAMIC	GRM39 25V F 104Z PT	1
				C226	0GP04104ZF	CP-C-CERAMIC	GRM39 25V F 104Z PT	1
				C227	0GP04104ZF	CP-C-CERAMIC	GRM39 25V F 104Z PT	1
				C228	0GP04104ZF	CP-C-CERAMIC	GRM39 25V F 104Z PT	1
				C229	0GP04104ZF	CP-C-CERAMIC	GRM39 25V F 104Z PT	1
				C230	0KT912R2MT	C-EL	YXA 50V 2.2MF-M TP 5X11	1
				C231	0ET91470MT	C-EL	YXA 16V 47MF-M TP 5X11	1
				C232	0ET91101MT	C-EL	YXA 16V 100MF-M TP 5X11	1
				C233	0KT91220MT	C-EL	YXA 50V 22MF-M TP 5X11	1
				C234	0KT91100MT	C-EL	YXA 50V 10MF-M TP 5X11	1
				C351	0KP03300JC	CP-C-CERAMIC	GRM39 50V CH 300J PT	1
				C352	0KP03300JC	CP-C-CERAMIC	GRM39 50V CH 300J PT	1
				C353	0ET91470MT	C-EL	YXA 16V 47MF-M TP 5X11	1
				C354	0KP04103ZF	CP-C-CERAMIC	GRM39 50V F 103Z PT	1
				C355	0KP04103ZF	CP-C-CERAMIC	GRM39 50V F 103Z PT	1
				C356	0ET91470MT	C-EL	YXA 16V 47MF-M TP 5X11	1
				C357	0KP04103ZF	CP-C-CERAMIC	GRM39 50V F 103Z PT	1
				C360	0KP04103ZF	CP-C-CERAMIC	GRM39 50V F 103Z PT	1
				C361	0ET91470MT	C-EL	YXA 16V 47MF-M TP 5X11	1
				C362	0ET91470MT	C-EL	YXA 16V 47MF-M TP 5X11	1
				C363	0KP04103ZF	CP-C-CERAMIC	GRM39 50V F 103Z PT	1
				C381	0GT91101MT	C-EL	YXA 25V 100MF-M TP 6.3X11	1
				C401	0GT50101MT	C-EL	PJ 25V 100MF-M TP 6.3X15	1
				C402	0GP04104ZF	CP-C-CERAMIC	GRM39 25V F 104Z PT	1
				C404	0NT40274JT	C-PLASTIC	ECQ-V1 274J M3 (TP)	1
				C406	0KT50101MT	C-EL	PJ 50V 100MF-M TP 8X20	1
				C407	0GT50101MT	C-EL	PJ 25V 100MF-M TP 6.3X15	1
				C451	0GP04104ZF	CP-C-CERAMIC	GRM39 25V F 104Z PT	1
				C452	0GP04104ZF	CP-C-CERAMIC	GRM39 25V F 104Z PT	1
				C453	0EK90105ZF	CP-C-CERAMIC	GRM40 16V F 105Z PT	1
				C454	0NM871R0MW	C-EL	KME 100V 1MF-M TP 5X11	1
				C455	0EK90105ZF	CP-C-CERAMIC	GRM40 16V F 105Z PT	1
				C501	0KP04103ZF	CP-C-CERAMIC	GRM39 50V F 103Z PT	1
				C502	0RP87103JF	C-PLASTIC	ECQ-E 2103J F3	1
				C503	0KT91100MT	C-EL	YXA 50V 10MF-M TP 5X11	1
				C505	0KT91100MT	C-EL	YXA 50V 10MF-M TP 5X11	1
				C506	0GT91331MT	C-EL	YXA 25V 330MF-M TP 10X12.5	1
				C511	02K1E822HF	C-PLASTIC	ECWH20822HVB	1
				C512	02K1E752HF	C-PLASTIC	ECWH20752HVB	1
				C513	06K1E153HF	C-PLASTIC	ECWH16153HVB	1

A	M	S	X	SYMB.	CODE	NAME	DESCRIPTION	QTY
				C514	06K1E153HF	C-PLASTIC	ECWH16153HVB	1
				C516	0RT32364JF	C-PLASTIC	ECWF2364JBB	1
				C517	0RT32394JF	C-PLASTIC	ECWF2394JBB	1
				C518	0RT32334JF	C-PLASTIC	ECWF2334JBB	1
				C519	0RT32105JF	C-PLASTIC	ECWF2105JBB	1
				C520	0RT32914JF	C-PLASTIC	ECWF2914JBB	1
				C531	0IT50331MT	C-EL	PJ 35V 330MF-M TP 10X20	1
				C532	0IT50331MT	C-EL	PJ 35V 330MF-M TP 10X20	1
				C533	0GP04104ZF	CP-C-CERAMIC	GRM39 25V F 104Z PT	1
				C534	0GP04104ZF	CP-C-CERAMIC	GRM39 25V F 104Z PT	1
				C535	0ET91470MT	C-EL	YXA 16V 47MF-M TP 5X11	1
				C601	0EK90105ZF	CP-C-CERAMIC	GRM40 16V F 105Z PT	1
				C602	0GP04104ZF	CP-C-CERAMIC	GRM39 25V F 104Z PT	1
				C603	0GP04104ZF	CP-C-CERAMIC	GRM39 25V F 104Z PT	1
				C604	0GP04104ZF	CP-C-CERAMIC	GRM39 25V F 104Z PT	1
				C605	0GP04104ZF	CP-C-CERAMIC	GRM39 25V F 104Z PT	1
				C606	0KQ16334J1	C-PLASTIC	ECQ-V1H 334J L3 (TP)	1
				C607	0ET91470MT	C-EL	YXA 16V 47MF-M TP 5X11	1
				C608	0KT91330MT	C-EL	YXA 50V 33MF-M TP 5X11	1
				C609	0KT91100MT	C-EL	YXA 50V 10MF-M TP 5X11	1
				C610	0GP04104ZF	CP-C-CERAMIC	GRM39 25V F 104Z PT	1
				C611	0GP04104ZF	CP-C-CERAMIC	GRM39 25V F 104Z PT	1
				C612	0GP04104ZF	CP-C-CERAMIC	GRM39 25V F 104Z PT	1
				C613	0KT91100MT	C-EL	YXA 50V 10MF-M TP 5X11	1
				C614	0ET91471MT	C-EL	YXA 16V 470MF-M TP 8X11.5	1
				C615	0KP04103ZF	CP-C-CERAMIC	GRM39 50V F 103Z PT	1
				C616	0FP08104M1	CP-C-TANTAL	TEMSVA21D104M-8R	1
				C617	0KQ16104J1	C-PLASTIC	ECQ-V1H 104J L3 (TP)	1
				C618	0KP03471JC	CP-C-CERAMIC	GRM39 50V CH 471J PT	1
				C619	0KP04103ZF	CP-C-CERAMIC	GRM39 50V F 103Z PT	1
				C620	0KP04222KB	CP-C-CERAMIC	GRM39 50V B 222K PT	1
				C621	0KT912R2MT	C-EL	YXA 50V 2.2MF-M TP 5X11	1
				C622	0KP04103ZF	CP-C-CERAMIC	GRM39 50V F 103Z PT	1
				C623	0KP03101JC	CP-C-CERAMIC	GRM39 50V CH 101J PT	1
				C624	0KT911R0MT	C-EL	YXA 50V 1MF-M TP 5X11	1
				C625	0KP764R7MT	C-EL	KME-BP 50V VB 4.7MF-M TP 5X11	1
				C626	0KT91100MT	C-EL	YXA 50V 10MF-M TP 5X11	1
				C627	0KP04102KB	CP-C-CERAMIC	GRM39 50V B 102K PT	1
				C628	0GP04104ZF	CP-C-CERAMIC	GRM39 25V F 104Z PT	1
				C629	0KP04103ZF	CP-C-CERAMIC	GRM39 50V F 103Z PT	1
				C630	0KP04103ZF	CP-C-CERAMIC	GRM39 50V F 103Z PT	1
				C631	0KP04103ZF	CP-C-CERAMIC	GRM39 50V F 103Z PT	1
				C632	0KP04103ZF	CP-C-CERAMIC	GRM39 50V F 103Z PT	1
				C633	0KP04103ZF	CP-C-CERAMIC	GRM39 50V F 103Z PT	1
				C634	0KP04103ZF	CP-C-CERAMIC	GRM39 50V F 103Z PT	1
				C702	0RQ646R8MP	C-EL	KXB 250V 6.80MF-M MC 18X40	1
				C703	0ZK1F224JF	C-PLASTIC	ECQ-E 10224J FB	1
				C704	06H73102JF	C-PLASTIC	DKR 1600V 102J SRT	1
				C705	0NK50682JM	C-PLASTIC	DTW 100V 682J TP	1
				C711	0KT91100MT	C-EL	YXA 50V 10MF-M TP 5X11	1
				C712	0KT91100MT	C-EL	YXA 50V 10MF-M TP 5X11	1
				C713	0KH81472KB	C-CERAMIC	DD107-959 B 472K 50V TP	1
				C721	0ET91101MT	C-EL	YXA 16V 100MF-M TP 5X11	1
				C722	0KP764R7MT	C-EL	KME-BP 50V VB 4.7MF-M TP 5X11	1
				C723	0KT91100MT	C-EL	YXA 50V 10MF-M TP 5X11	1
				C724	0RP97224KF	C-PLASTIC	ECQ-E 2224K F3	1
				C731	0RP97104KF	C-PLASTIC	ECQ-E 2104K F3	1
S				C901	0RP15104MS	C-PLASTIC	LFX 250V 104M	1
S				C902	0RT04102ME	C-CERAMIC	DE0910-778 E 102M-KX	1
S				C903	0RT04102ME	C-CERAMIC	DE0910-778 E 102M-KX	1
S				C904	0RT04222ME	C-CERAMIC	DE1210-778 E 222M-KX	1
S				C905	0CJ1D122M1	C-EL	MXC 200V 1200MF-M 30X40	1
S				C905	0QT35122M1	C-EL	GU 200V 1200MF-M 30X40	CR
				C906	0UP56104JF	C-PLASTIC	ECQ-E 4104J FB	1

A	M	S	X	SYMB.	CODE	NAME	DESCRIPTION	QTY
				C907	0ZQ49102KR	C-CERAMIC	DE0905-979 R 102K 1K	1
				C908	0ZQ49102KR	C-CERAMIC	DE0905-979 R 102K 1K	1
				C909	02P43102KR	C-CERAMIC	DE1210-1 (H)R 102K 2KV SRT	1
				C910	0IT91471MT	C-EL	YXA 35V 470MF-M TP 10X16	1
				C911	0GP04223KE	CP-C-CERAMIC	GRM39 25V B 223K PT	1
				C912	0GP03561JC	CP-C-CERAMIC	GRM39 25V CH 561J PT	1
				C913	0EK90474KS	CP-C-CERAMIC	GRM40 16V B 474K PT	1
				C914	0KP04103ZF	CP-C-CERAMIC	GRM39 50V F 103Z PT	1
				C915	0EK90334KB	CP-C-CERAMIC	GRM40 16V B 334K PT	1
				C916	0KK90223KB	CP-C-CERAMIC	GRM40 50V B 223K PT	1
				C921	0RT28471M2	C-EL	MXC 250V 470MF-M 22X45	1
				C921	0RT85471M1	C-EL	GU 250V 470MF-M 22X50	OR
				C922	0GT50222MP	C-EL	PJ 25V 2200MF-M 12.5X40	1
				C923	0CT50222MP	C-EL	PJ 10V 2200MF-M MC 12.5X25	1
				C924	0GT50681MP	C-EL	PJ 25V 680MF-M 10X31.5	1
				C925	0GP04104ZF	CP-C-CERAMIC	GRM39 25V F 104Z PT	1
				C926	0RP87473JF	C-PLASTIC	ECQ-E 2473J F3	1
				C927	0KT91100MT	C-EL	YXA 50V 10MF-M TP 5X11	1
				C928	0EK90105ZF	CP-C-CERAMIC	GRM40 16V F 105Z PT	1
				C929	0ET91221MT	C-EL	YXA 16V 220MF-M TP 6.3X11	1
				C930	0KT91100MT	C-EL	YXA 50V 10MF-M TP 5X11	1
				C931	0GP04104ZF	CP-C-CERAMIC	GRM39 25V F 104Z PT	1
				C951	0GP04104ZF	CP-C-CERAMIC	GRM39 25V F 104Z PT	1
				C952	0RP87104KF	C-PLASTIC	ECQ-E 2104K F3	1
				C953	0RJ1E470MP	C-EL	KMX 250V 47MF-M MC 16X25	1
				C954	0ET91470MT	C-EL	YXA 16V 47MF-M TP 5X11	1
				C955	0GP03102JC	CP-C-CERAMIC	GRM39 25V CH 102J PT	1
				C956	0EK90105ZF	CP-C-CERAMIC	GRM40 16V F 105Z PT	1
				C957	0KT91100MT	C-EL	YXA 50V 10MF-M TP 5X11	1
				C958	0RP87103JF	C-PLASTIC	ECQ-E 2103J F3	1
				C959	0KK90223KB	CP-C-CERAMIC	GRM40 50V B 223K PT	1
				C960	0KT91100MT	C-EL	YXA 50V 10MF-M TP 5X11	1
				C961	0ET91470MT	C-EL	YXA 16V 47MF-M TP 5X11	1
				C962	0KP03820JC	CP-C-CERAMIC	GRM39 50V CH 820J PT	1
				C963	0KP04103KB	CP-C-CERAMIC	GRM39 50V B 103K PT	1
				C971	0EP76100MT	C-EL	KME-BP 16V VB 10MF-M TP 5X11	1
				C972	0EK90105ZF	CP-C-CERAMIC	GRM40 16V F 105Z PT	1
				C973	0KP04102KB	CP-C-CERAMIC	GRM39 50V B 102K PT	1
				CN102	05V03381A1	ASSY HARNESS	ASSY HARNESS CN102	1
				CN201	00J40273A5	CN	B6B-EH (RED)	1
				CN202	00J40190A5	CN	B6B-EH	1
				CN251	08R40362A1	CN-D-SUB	CHS3115-0126	1
				CN251	30M0D007A1	CN-D-SUB	5510-15S-RC-Z	OR
				CN252	05V03383A1	ASSY HARNESS	ASSY HARNESS CN101	1
				CN351	00J40642A5	CN	B6B-PH-K-S	1
				CN352	00J40642A3	CN	B4B-PH-K-S	1
				CN353	00J40644A3	CN	S4B-PH-K-S	1
				CN401	00F40752A2	CN	W-P3002(2P)	1
				CN511	08F40149A2	CN	B2P-LV-TN	1
				CN703	05V03382A1	ASSY HARNESS	ASSY HARNESS CN703	1
	S			CN901	00F40916A1	CN	B2P3-VH	1
	S			CN903	00F40019A1	CN	YP115S-2P	1
				CN904	00J40642A1	CN	B2B-PH-K-S	1
				CN951	00J40190A1	CN	B2B-EH	1
A				D101	08H25035C1	CP-D	DAN217 (T146)	1
A				D102	00H25737C1	CP-D	DAN202K (T146)	1
A				D103	08H25657A1	CP-D	1SS355 (TE17) TP	1
A				D104	08H25035C1	CP-D	DAN217 (T146)	1
A				D105	08H25035C1	CP-D	DAN217 (T146)	1
A				D201	08H25035C1	CP-D	DAN217 (T146)	1
A				D202	08H25035C1	CP-D	DAN217 (T146)	1
A				D203	08H25035C1	CP-D	DAN217 (T146)	1
A				D204	08H25657A1	CP-D	1SS355 (TE17) TP	1
A				D221	08H25035C1	CP-D	DAN217 (T146)	1

A	MIS X	SYMB.	CODE	NAME	DESCRIPTION	QTY
A		D222	08H25035C1	CP-D	DAN217 (T146)	1
A		D223	08H25035C1	CP-D	DAN217 (T146)	1
A		D381	08H25035C1	CP-D	DAN217 (T146)	1
A		D382	08H25035C1	CP-D	DAN217 (T146)	1
A		D383	08H25657A1	CP-D	1SS355 (TE17) TP	1
		D401	08F25847T1	D	ERA18-02V3 TP	1
A		D451	08H25035C1	CP-D	DAN217 (T146)	1
A		D452	08H25035C1	CP-D	DAN217 (T146)	1
A		D453	00H25737C1	CP-D	DAN202K (T146)	1
A		D501	08H25657A1	CP-D	1SS355 (TE17) TP	1
A		D503	08H25657A1	CP-D	1SS355 (TE17) TP	1
		D511	08N25211A2	D	DD54RCLS	1
		D512	08F25847T1	D	ERA18-02V3 TP	1
A		D513	08H25657A1	CP-D	1SS355 (TE17) TP	1
A		D514	08H25657A1	CP-D	1SS355 (TE17) TP	1
A		D515	08H25657A1	CP-D	1SS355 (TE17) TP	1
A		D517	08H25657A1	CP-D	1SS355 (TE17) TP	1
		D531	09H25134C1	CP-D	U1DL44A (TE12L)	1
		D532	09H25134C1	CP-D	U1DL44A (TE12L)	1
		D536	08H25119A1	CP-D	HSM83-TL	1
		D537	08H25119A1	CP-D	HSM83-TL	1
A		D601	08H25035C1	CP-D	DAN217 (T146)	1
		D602	08F25847T1	D	ERA18-02V3 TP	1
		D603	09H25134C1	CP-D	U1DL44A (TE12L)	1
		D701	08N25917T1	DIODE	1GU42A (TPA3)	1
		D702	08N25917T1	DIODE	1GU42A (TPA3)	1
		D703	08N25238T1	D	05NU42 (TPA3)	1
A		D704	08H25657A1	CP-D	1SS355 (TE17) TP	1
		D705	08N25238T1	D	05NU42 (TPA3)	1
		D706	08N25917T1	DIODE	1GU42A (TPA3)	1
		D711	00N25030T1	D	1SS244 T-77	1
A		D721	08H25657A1	CP-D	1SS355 (TE17) TP	1
		D731	09H25134C1	CP-D	U1DL44A (TE12L)	1
		D901	00N25030T1	D	1SS244 T-77	1
		D902	00G6F003F1	D	1R5JU41 (LC7-15)	1
		D902	08R25431F1	D	ERC38-06E	OR
		D903	08J25562T1	D	11EFS2-TA1 B2	1
A		D904	08H25657A1	CP-D	1SS355 (TE17) TP	1
		D921	08N25321A1	D	5JLZ47	1
		(D921)	00NCD024A1	RADIATOR	BPUE10-35	1
		(D921)	00NCD024A1	RADIATOR	BPUE10-35	OR
		(D921)	08R49039A2	RADIATOR	OSH-1035-SPL	OR
		(D921)	08R49039A2	RADIATOR	OSH-1035-SPL	OR
		(D921)	0FF623010D	SCREW	SC-SEMS-P-PAN M3X10(W/SW) ZN/FE	1
		D922	00J25103F1	D	ERC84-009L	1
		D923	00J25103F1	D	ERC84-009L	1
		D924	08J25978A1	D	RL2Z LF-B2	1
		D925	08J25562T1	D	11EFS2-TA1 B2	1
A		D926	00H25737C1	CP-D	DAN202K (T146)	1
		D927	08J25562T1	D	11EFS2-TA1 B2	1
A		D928	08H25657A1	CP-D	1SS355 (TE17) TP	1
		D929	09H25134C1	CP-D	U1DL44A (TE12L)	1
A		D930	08H25035C1	CP-D	DAN217 (T146)	1
		D951	00N25030T1	D	1SS244 T-77	1
		D952	00R25170A2	D	1R5GU41	1
A		D953	08H25657A1	CP-D	1SS355 (TE17) TP	1
A		D954	08H25657A1	CP-D	1SS355 (TE17) TP	1
S		F701	08N32018A1	FUSE	215001 1A	1
S		F901	08N32018A9	FUSE	21506.3	1
		FC701	08N51217T1	FUSE-HOLDER	PFC5000-0202	1
		FC702	08N51217T1	FUSE-HOLDER	PFC5000-0202	1
		FC901	08N51217T1	FUSE-HOLDER	PFC5000-0202	1
		FC902	08N51217T1	FUSE-HOLDER	PFC5000-0202	1
		L201	00K00101K0	L-PEAKING	ELC606RA-101K TP	1

A	M	S	X	SYMB.	CODE	NAME	DESCRIPTION	QTY
				L512	05F16750A1	H.LIN	ETS75	1
				L513	00M22331K1	L-CHOKE	LHL10TB331K TP	1
				L514	00M22102J1	L-CHOKE	LHL10TB102J TP	1
				L531	00M22681K1	L-CHOKE	LHL10TB681K TP	1
				L533	00M22100K1	L-CHOKE	LHL10TB100K TP	1
				L534	00M22100K1	L-CHOKE	LHL10TB100K TP	1
				L601	00K00101K0	L-PEAKING	EL0606RA-101K TP	1
				L701	00M22101K1	L-CHOKE	LHL10TB101K TP	1
				L702	00M223R3M1	L-CHOKE	LHL10TB3R3M TP	1
				L703	09F50164T1	NF	BL02RN1-R62T2	1
				L721	00K00101K0	L-PEAKING	EL0606RA-101K TP	1
S				L901	00F1H011A1	L-LINE-F	ELF20N027A	1
				L902	09F50164T1	NF	BL02RN1-R62T2	1
				L921	00M22101K1	L-CHOKE	LHL10TB101K TP	1
				L922	00K00101K0	L-PEAKING	EL0606RA-101K TP	1
				L923	00K00101K0	L-PEAKING	EL0606RA-101K TP	1
				L924	00M22101K1	L-CHOKE	LHL10TB101K TP	1
				L925	00M21101K1	L-CHOKE	LHL08TB101K TP	1
				L926	00M213R3M1	L-CHOKE	LHL08TB3R3M TP	1
				L951	05F16751C1	L-CHOKE	A3400969	1
				L952	00K00101K0	L-PEAKING	EL0606RA-101K TP	1
				L953	01F38923T9	CP-COIL	BLM11A221SPT TP(SMD)	1
				L954	01F38923T9	CP-COIL	BLM11A221SPT TP(SMD)	1
S				NTH901	08N38366A1	R-THERMISTOR	NTH22D6R0LA	1
S				PC901	09F28369A2	IC-PC	TLP721F D4-GRLM	1
S				PTH901	08J29031B1	R-POSISTOR	PTH451C263BG8R0M140A	1
A				Q101	0AK41037KZ	CP-TR	2SA1037K T-146 Q,R,S	1
A				Q102	0CK42412KZ	CP-TR	2SC2412K T-146 Q,R,S	1
A				Q201	0AK41037KZ	CP-TR	2SA1037K T-146 Q,R,S	1
A				Q202	0AK41037KZ	CP-TR	2SA1037K T-146 Q,R,S	1
A				Q203	0AK41037KZ	CP-TR	2SA1037K T-146 Q,R,S	1
A				Q204	0CK42412KZ	CP-TR	2SC2412K T-146 Q,R,S	1
A				Q205	0CK42412KZ	CP-TR	2SC2412K T-146 Q,R,S	1
A				Q206	0CK42412KZ	CP-TR	2SC2412K T-146 Q,R,S	1
				Q207	0AK41364ZZ	CP-TR	2SA1364	1
A				Q208	00H29365T1	CP-TR-DIGITAL	DTC143EK T-146	1
A				Q221	0AK41037KZ	CP-TR	2SA1037K T-146 Q,R,S	1
A				Q222	0AK41037KZ	CP-TR	2SA1037K T-146 Q,R,S	1
A				Q351	00H29358T1	CP-TR-DIGITAL	DTC144EK T-146	1
A				Q381	0AK41037KZ	CP-TR	2SA1037K T-146 Q,R,S	1
A				Q501	0KG12961ZZ	TR-FET	2SK2961 TP	1
A				Q502	0CK42412KZ	CP-TR	2SC2412K T-146 Q,R,S	1
				Q503	0BF21569AE	TR	2SB1569A-E	1
				(Q503)	30N0D024A1	RADIATOR	BPUE10-35	1
				(Q503)	00N0D024A1	RADIATOR	BPUE10-35	OR
				(Q503)	38R49039A2	RADIATOR	OSH-1035-SPL	OR
				(Q503)	08R49039A2	RADIATOR	OSH-1035-SPL	OR
				(Q503)	0FF623010D	SCREW	SC-SEMS-P-PAN M3X10(W/SW) ZN/FE	1
A				Q504	0CK42412KZ	CP-TR	2SC2412K T-146 Q,R,S	1
A				Q505	0AK41037KZ	CP-TR	2SA1037K T-146 Q,R,S	1
				Q511	0CF25244NZ	TR	2SC5244-NU	1
S				(Q511)	08R52554A1	INSULATOR	BFG45(25X30)D-7 DSN-CSSX-G53002(UL)	1
A				Q512	01H29733T2	CP-TR-DIGITAL	DTC143ZKA T-146	1
A				Q513	01H29733T2	CP-TR-DIGITAL	DTC143ZKA T-146	1
A				Q514	01H29733T2	CP-TR-DIGITAL	DTC143ZKA T-146	1
A				Q515	01H29733T2	CP-TR-DIGITAL	DTC143ZKA T-146	1
				Q531	0CH24002ZE	TR	2SC4002-E TP	1
A				Q601	00H29340T1	CP-TR-DIGITAL	DTA144EK T-146	1
A				Q701	09F24556A1	TR-FET	2SK2847	1
A	S			Q901	00G8A004A1	TR-FET	FS18RM-10 A8	1
				(Q901)	00N0D002A1	RADIATOR	OSV-15100C-L65-BPWL	1
				(Q901)	0FF623010D	SCREW	SC-SEMS-P-PAN M3X10(W/SW) ZN/FE	1
A				Q921	00H29365T1	CP-TR-DIGITAL	DTC143EK T-146	1
A				Q922	01H29733T2	CP-TR-DIGITAL	DTC143ZKA T-146	1

A	M	S	X	SYMB.	CODE	NAME	DESCRIPTION	QTY
A				Q951	0AK41721ZZ	CP-TR	2SA1721-O(TE85L)	1
A				Q952	0JG00512ZZ	TR-FET	2SJ512	1
A				Q971	0CK42412KZ	CP-TR	2SC2412K T-146 Q,R,S	1
				R101	0ZL49302JA	CP-R-CARBON	RK73K2A 1/10W 3.0K-J TP(TD)	1
				R102	0ZL49334JA	CP-R-CARBON	RK73K2A 1/10W 330K-J TP(TD)	1
				R103	0ZL49334JA	CP-R-CARBON	RK73K2A 1/10W 330K-J TP(TD)	1
				R104	0ZL49393JA	CP-R-CARBON	RK73K2A 1/10W 39K-J TP(TD)	1
				R105	0ZL49334JA	CP-R-CARBON	RK73K2A 1/10W 330K-J TP(TD)	1
				R106	0ZL49102JA	CP-R-CARBON	RK73K2A 1/10W 1.0K-J TP(TD)	1
				R107	0ZL49472JA	CP-R-CARBON	RK73K2A 1/10W 4.7K-J TP(TD)	1
				R108	0ZL49393JA	CP-R-CARBON	RK73K2A 1/10W 39K-J TP(TD)	1
				R109	0ZL49681JA	CP-R-CARBON	RK73K2A 1/10W 680-J TP(TD)	1
				R110	0ZL49392JA	CP-R-CARBON	RK73K2A 1/10W 3.9K-J TP(TD)	1
				R111	0ZL49823JA	CP-R-CARBON	RK73K2A 1/10W 82K-J TP(TD)	1
				R112	0ZL49182JA	CP-R-CARBON	RK73K2A 1/10W 1.8K-J TP(TD)	1
				R113	0ZL49102JA	CP-R-CARBON	RK73K2A 1/10W 1.0K-J TP(TD)	1
				R114	0ZL49102JA	CP-R-CARBON	RK73K2A 1/10W 1.0K-J TP(TD)	1
				R115	0ZL49103JA	CP-R-CARBON	RK73K2A 1/10W 10K-J TP(TD)	1
				R116	0ZL49103JA	CP-R-CARBON	RK73K2A 1/10W 10K-J TP(TD)	1
				R117	0ZL49103JA	CP-R-CARBON	RK73K2A 1/10W 10K-J TP(TD)	1
				R118	0ZL49103JA	CP-R-CARBON	RK73K2A 1/10W 10K-J TP(TD)	1
				R119	0ZL49103JA	CP-R-CARBON	RK73K2A 1/10W 10K-J TP(TD)	1
				R120	0ZL49393JA	CP-R-CARBON	RK73K2A 1/10W 39K-J TP(TD)	1
				R201	0ZL481501F	CP-R-CARBON	RK73H2A 1/10W 1.50K-F TP(TD)	1
				R202	0BL4875R0F	CP-R-CARBON	RK73H2E 1/4W 75.0-F TP(TD)	1
				R203	0ZL49332JA	CP-R-CARBON	RK73K2A 1/10W 3.3K-J TP(TD)	1
				R204	0ZL484640F	CP-R-CARBON	RK73H2A 1/10W 464-F TP(TD)	1
				R205	0ZL49103JA	CP-R-CARBON	RK73K2A 1/10W 10K-J TP(TD)	1
				R206	0ZL481501F	CP-R-CARBON	RK73H2A 1/10W 1.50K-F TP(TD)	1
				R207	0BL4875R0F	CP-R-CARBON	RK73H2E 1/4W 75.0-F TP(TD)	1
				R208	0ZL49332JA	CP-R-CARBON	RK73K2A 1/10W 3.3K-J TP(TD)	1
				R209	0ZL484640F	CP-R-CARBON	RK73H2A 1/10W 464-F TP(TD)	1
				R210	0ZL49103JA	CP-R-CARBON	RK73K2A 1/10W 10K-J TP(TD)	1
				R211	0ZL481501F	CP-R-CARBON	RK73H2A 1/10W 1.50K-F TP(TD)	1
				R212	0BL4875R0F	CP-R-CARBON	RK73H2E 1/4W 75.0-F TP(TD)	1
				R213	0ZL49332JA	CP-R-CARBON	RK73K2A 1/10W 3.3K-J TP(TD)	1
				R214	0ZL484640F	CP-R-CARBON	RK73H2A 1/10W 464-F TP(TD)	1
				R215	0ZL49103JA	CP-R-CARBON	RK73K2A 1/10W 10K-J TP(TD)	1
				R216	0ZL49153JA	CP-R-CARBON	RK73K2A 1/10W 15K-J TP(TD)	1
				R217	0ZL49472JA	CP-R-CARBON	RK73K2A 1/10W 4.7K-J TP(TD)	1
				R218	0ZL49102JA	CP-R-CARBON	RK73K2A 1/10W 1.0K-J TP(TD)	1
				R219	0BL083R3JL	R-FUSING	RF25SJ 1/4W 3.3-J L(L10)	1
				R221	0ZL49101JA	CP-R-CARBON	RK73K2A 1/10W 100-J TP(TD)	1
				R222	0ZL49101JA	CP-R-CARBON	RK73K2A 1/10W 100-J TP(TD)	1
				R223	0ZL49101JA	CP-R-CARBON	RK73K2A 1/10W 100-J TP(TD)	1
				R224	0ZL49471JA	CP-R-CARBON	RK73K2A 1/10W 470-J TP(TD)	1
				R225	0ZL49122JA	CP-R-CARBON	RK73K2A 1/10W 1.2K-J TP(TD)	1
				R226	0ZL49223JA	CP-R-CARBON	RK73K2A 1/10W 22K-J TP(TD)	1
				R227	0ZL49823JA	CP-R-CARBON	RK73K2A 1/10W 82K-J TP(TD)	1
				R228	0ZL49473JA	CP-R-CARBON	RK73K2A 1/10W 47K-J TP(TD)	1
				R229	0ZL49223JA	CP-R-CARBON	RK73K2A 1/10W 22K-J TP(TD)	1
				R351	0ZL49103JA	CP-R-CARBON	RK73K2A 1/10W 10K-J TP(TD)	1
				R352	0ZL49472JA	CP-R-CARBON	RK73K2A 1/10W 4.7K-J TP(TD)	1
				R353	0ZL49103JA	CP-R-CARBON	RK73K2A 1/10W 10K-J TP(TD)	1
				R354	0ZL49103JA	CP-R-CARBON	RK73K2A 1/10W 10K-J TP(TD)	1
				R355	0ZL49102JA	CP-R-CARBON	RK73K2A 1/10W 1.0K-J TP(TD)	1
				R356	0ZL49103JA	CP-R-CARBON	RK73K2A 1/10W 10K-J TP(TD)	1
				R357	0ZL49102JA	CP-R-CARBON	RK73K2A 1/10W 1.0K-J TP(TD)	1
				R358	0ZL49103JA	CP-R-CARBON	RK73K2A 1/10W 10K-J TP(TD)	1
				R359	0ZL49102JA	CP-R-CARBON	RK73K2A 1/10W 1.0K-J TP(TD)	1
				R360	0ZL49103JA	CP-R-CARBON	RK73K2A 1/10W 10K-J TP(TD)	1
				R361	0ZL49102JA	CP-R-CARBON	RK73K2A 1/10W 1.0K-J TP(TD)	1
				R362	0ZL49103JA	CP-R-CARBON	RK73K2A 1/10W 10K-J TP(TD)	1
				R363	0ZL49102JA	CP-R-CARBON	RK73K2A 1/10W 1.0K-J TP(TD)	1

A	M	S	X	SYMB.	CODE	NAME	DESCRIPTION	QTY
				R364	0ZL49103JA	CP-R-CARBON	RK73K2A 1/10W 10K-J TP(TD)	1
				R365	0ZL49103JA	CP-R-CARBON	RK73K2A 1/10W 10K-J TP(TD)	1
				R366	0ZL49102JA	CP-R-CARBON	RK73K2A 1/10W 1.0K-J TP(TD)	1
				R367	0ZL49103JA	CP-R-CARBON	RK73K2A 1/10W 10K-J TP(TD)	1
				R368	0ZL49102JA	CP-R-CARBON	RK73K2A 1/10W 1.0K-J TP(TD)	1
				R369	0ZL49103JA	CP-R-CARBON	RK73K2A 1/10W 10K-J TP(TD)	1
				R370	0ZL49102JA	CP-R-CARBON	RK73K2A 1/10W 1.0K-J TP(TD)	1
				R371	0ZL49102JA	CP-R-CARBON	RK73K2A 1/10W 1.0K-J TP(TD)	1
				R372	0ZL49103JA	CP-R-CARBON	RK73K2A 1/10W 10K-J TP(TD)	1
				R373	0ZL49472JA	CP-R-CARBON	RK73K2A 1/10W 4.7K-J TP(TD)	1
				R374	0ZL49472JA	CP-R-CARBON	RK73K2A 1/10W 4.7K-J TP(TD)	1
				R375	0ZL49103JA	CP-R-CARBON	RK73K2A 1/10W 10K-J TP(TD)	1
				R376	0ZL49223JA	CP-R-CARBON	RK73K2A 1/10W 22K-J TP(TD)	1
				R377	0ZL49104JA	CP-R-CARBON	RK73K2A 1/10W 100K-J TP(TD)	1
				R378	0ZL49104JA	CP-R-CARBON	RK73K2A 1/10W 100K-J TP(TD)	1
				R379	0ZL49102JA	CP-R-CARBON	RK73K2A 1/10W 1.0K-J TP(TD)	1
				R380	0ZL49102JA	CP-R-CARBON	RK73K2A 1/10W 1.0K-J TP(TD)	1
				R381	0ZL49123JA	CP-R-CARBON	RK73K2A 1/10W 12K-J TP(TD)	1
				R382	0ZL49103JA	CP-R-CARBON	RK73K2A 1/10W 10K-J TP(TD)	1
				R383	0ZL49221JA	CP-R-CARBON	RK73K2A 1/10W 220-J TP(TD)	1
				R384	0ZL49103JA	CP-R-CARBON	RK73K2A 1/10W 10K-J TP(TD)	1
				R385	0ZL49102JA	CP-R-CARBON	RK73K2A 1/10W 1.0K-J TP(TD)	1
				R386	0ZL49102JA	CP-R-CARBON	RK73K2A 1/10W 1.0K-J TP(TD)	1
				R387	0ZL49102JA	CP-R-CARBON	RK73K2A 1/10W 1.0K-J TP(TD)	1
				R388	0ZL49102JA	CP-R-CARBON	RK73K2A 1/10W 1.0K-J TP(TD)	1
				R389	0ZL49102JA	CP-R-CARBON	RK73K2A 1/10W 1.0K-J TP(TD)	1
				R390	0ZL49102JA	CP-R-CARBON	RK73K2A 1/10W 1.0K-J TP(TD)	1
				R391	0ZL49102JA	CP-R-CARBON	RK73K2A 1/10W 1.0K-J TP(TD)	1
				R392	0ZL49102JA	CP-R-CARBON	RK73K2A 1/10W 1.0K-J TP(TD)	1
				R393	0ZL49102JA	CP-R-CARBON	RK73K2A 1/10W 1.0K-J TP(TD)	1
				R402	0ZL484702F	CP-R-CARBON	RK73H2A 1/10W 47.0K-F TP(TD)	1
				R404	0ZL482401F	CP-R-CARBON	RK73H2A 1/10W 2.40K-F TP(TD)	1
				R406	0BL081R0JL	R-FUSING	RF25SJ 1/4W 1.0-J L(L10)	1
				R407	0EL09391JL	R-METAL OX	RSS 2 L15 390-J	1
				R408	0EL091R0JL	R-METAL OX	RSSX 2 L15 1.0-J	1
				R409	0ZL481002F	CP-R-CARBON	RK73H2A 1/10W 10.0K-F TP(TD)	1
				R410	0ZL481102F	CP-R-CARBON	RK73H2A 1/10W 11.0K-F TP(TD)	1
				R411	0FL094R7JL	R-METAL OX	RSSX 3 L20 4.7-J	1
				R451	0ZL49823JA	CP-R-CARBON	RK73K2A 1/10W 82K-J TP(TD)	1
				R452	0ZL49103JA	CP-R-CARBON	RK73K2A 1/10W 10K-J TP(TD)	1
				R453	0ZL49563JA	CP-R-CARBON	RK73K2A 1/10W 56K-J TP(TD)	1
				R454	0ZL49474JA	CP-R-CARBON	RK73K2A 1/10W 470K-J TP(TD)	1
				R455	0ZL49153JA	CP-R-CARBON	RK73K2A 1/10W 15K-J TP(TD)	1
				R456	0ZL483303F	CP-R-CARBON	RK73H2A 1/10W 330.0K-F TP(TD)	1
				R457	0ZL481302F	CP-R-CARBON	RK73H2A 1/10W 13.0K-F TP(TD)	1
				R501	0ZL49104JA	CP-R-CARBON	RK73K2A 1/10W 100K-J TP(TD)	1
				R502	0EL09820JL	R-METAL OX	RSS 2 L15 82-J	1
				R503	0ZL49223JA	CP-R-CARBON	RK73K2A 1/10W 22K-J TP(TD)	1
				R505	0ZL49183JA	CP-R-CARBON	RK73K2A 1/10W 18K-J TP(TD)	1
				R506	0ZL49222JA	CP-R-CARBON	RK73K2A 1/10W 2.2K-J TP(TD)	1
				R507	0BL49103JA	CP-R-CARBON	RK73K2E 1/4W 10K-J TP(TD)	1
				R508	0FL095R6JL	R-METAL OX	RSSX 3 L20 5.6-J	1
				R511	0DL09150JL	R-METAL OX	RSS 1 L12.5 15-J	1
				R512	0CL04104JT	R-CARBON	RD50SS T26 1/2W 100K-J TP	1
				R515	0EL09221JL	R-METAL OX	RSS 2 L15 220-J	1
				R516	0EL08220JL	R-FUSING	RF2SJ 2W 22-J L(L20)	1
				R531	0BL49332JA	CP-R-CARBON	RK73K2E 1/4W 3.3K-J TP(TD)	1
				R532	0ZL49123JA	CP-R-CARBON	RK73K2A 1/10W 12K-J TP(TD)	1
				R533	0BL492R2JA	CP-R-CARBON	RK73M2E 1/4W 2.2-J TP(TD)	1
				R535	0FS638R2K2	R-METAL OX	RSS 3 FB 8.2-K H2	1
				R536	0BL083R3JL	R-FUSING	RF25SJ 1/4W 3.3-J L(L10)	1
				R601	0ZL49473JA	CP-R-CARBON	RK73K2A 1/10W 47K-J TP(TD)	1
				R602	0ZL49103JA	CP-R-CARBON	RK73K2A 1/10W 10K-J TP(TD)	1
				R603	0ZL49103JA	CP-R-CARBON	RK73K2A 1/10W 10K-J TP(TD)	1

A	M	S	X	SYMB.	CODE	NAME	DESCRIPTION	QTY
				R604	0ZL49103JA	CP-R-CARBON	RK73K2A 1/10W 10K-J TP(TD)	1
				R605	0ZL49103JA	CP-R-CARBON	RK73K2A 1/10W 10K-J TP(TD)	1
				R606	0ZL481802F	CP-R-CARBON	RK73H2A 1/10W 18.0K-F TP(TD)	1
				R607	0ZL481242F	CP-R-CARBON	RK73H2A 1/10W 12.4K-F TP(TD)	1
				R608	0ZL49103JA	CP-R-CARBON	RK73K2A 1/10W 10K-J TP(TD)	1
				R609	0ZL49103JA	CP-R-CARBON	RK73K2A 1/10W 10K-J TP(TD)	1
				R610	0ZL49472JA	CP-R-CARBON	RK73K2A 1/10W 4.7K-J TP(TD)	1
				R611	0ZL49474JA	CP-R-CARBON	RK73K2A 1/10W 470K-J TP(TD)	1
				R612	0ZL481962F	CP-R-CARBON	RK73H2A 1/10W 19.6K-F TP(TD)	1
				R613	0ZL49154JA	CP-R-CARBON	RK73K2A 1/10W 150K-J TP(TD)	1
				R614	0ZL49472JA	CP-R-CARBON	RK73K2A 1/10W 4.7K-J TP(TD)	1
				R615	0ZL49392JA	CP-R-CARBON	RK73K2A 1/10W 3.9K-J TP(TD)	1
				R616	0ZL49102JA	CP-R-CARBON	RK73K2A 1/10W 1.0K-J TP(TD)	1
				R617	0ZL49103JA	CP-R-CARBON	RK73K2A 1/10W 10K-J TP(TD)	1
				R618	0ZL49474JA	CP-R-CARBON	RK73K2A 1/10W 470K-J TP(TD)	1
				R619	0ZL49103JA	CP-R-CARBON	RK73K2A 1/10W 10K-J TP(TD)	1
				R620	0ZL485601F	CP-R-CARBON	RK73H2A 1/10W 5.60K-F TP(TD)	1
				R621	0ZL49102JA	CP-R-CARBON	RK73K2A 1/10W 1.0K-J TP(TD)	1
				R622	0ZL49622JA	CP-R-CARBON	RK73K2A 1/10W 6.2K-J TP(TD)	1
				R623	0ZL49332JA	CP-R-CARBON	RK73K2A 1/10W 3.3K-J TP(TD)	1
				R624	0ZL49472JA	CP-R-CARBON	RK73K2A 1/10W 4.7K-J TP(TD)	1
				R625	0ZL49102JA	CP-R-CARBON	RK73K2A 1/10W 1.0K-J TP(TD)	1
				R626	0ZL49472JA	CP-R-CARBON	RK73K2A 1/10W 4.7K-J TP(TD)	1
				R627	0ZL49223JA	CP-R-CARBON	RK73K2A 1/10W 22K-J TP(TD)	1
				R628	0ZL49103JA	CP-R-CARBON	RK73K2A 1/10W 10K-J TP(TD)	1
				R629	0ZL481802F	CP-R-CARBON	RK73H2A 1/10W 18.0K-F TP(TD)	1
				R630	0ZL481132F	CP-R-CARBON	RK73H2A 1/10W 11.3K-F TP(TD)	1
				R631	0ZL49471JA	CP-R-CARBON	RK73K2A 1/10W 470-J TP(TD)	1
				R701	0HM13154JL	R-METAL.OX	SPR 5W 150K-J L(L35)	1
				R702	0CL08680JL	R-FUSING	RF50SJ 1/2W 68-J L(L12.5)	1
				R703	0ZL49102JA	CP-R-CARBON	RK73K2A 1/10W 1.0K-J TP(TD)	1
X				R704	0EL09R27JL	R-METAL.OX	RSSX 2 L15 0.27-J	1
				R711	0DL09820JL	R-METAL.OX	RSS 1 L12.5 82-J	1
X				R712	0ZL49223JA	CP-R-CARBON	RK73K2A 1/10W 22K-J TP(TD)	1
X				R713	0ZL49472JA	CP-R-CARBON	RK73K2A 1/10W 4.7K-J TP(TD)	1
X				R714	0ZL49224JA	CP-R-CARBON	RK73K2A 1/10W 220K-J TP(TD)	1
				R721	0ZL49103JA	CP-R-CARBON	RK73K2A 1/10W 10K-J TP(TD)	1
X				R722	0ZL49823JA	CP-R-CARBON	RK73K2A 1/10W 82K-J TP(TD)	1
				R723	0ZL49220JA	CP-R-CARBON	RK73K2A 1/10W 22-J TP(TD)	1
				R724	0ZL49220JA	CP-R-CARBON	RK73K2A 1/10W 22-J TP(TD)	1
				R731	0ZL49101JA	CP-R-CARBON	RK73K2A 1/10W 100-J TP(TD)	1
				R732	0DL081R0JL	R-FUSING	RF1SJ 1W 1.0-J L(L15)	1
S				R901	0CS79224JT	R-METAL.GL	RCP50 T52 220K-J TP	1
S				R902	0NM161ROKH	R-CEMENT	BGR 15Z RU 1.0-K	1
S				R903	0CS79224JT	R-METAL.GL	RCP50 T52 220K-J TP	1
X				R904	0BL49470JA	CP-R-CARBON	RK73K2E 1/4W 47-J TP(TD)	1
				R905	0ZL49220JA	CP-R-CARBON	RK73K2A 1/10W 22-J TP(TD)	1
				R906	0JS65153JV	R-METAL	RSV7FB-15K-J DH	1
				R907	0EL32R15JM	R-METAL.PLATE	BPR 28 2W 0.15-J	1
				R908	0JS65101JV	R-METAL	RSV7FB-100-J DH	1
				R909	0ZL49330JA	CP-R-CARBON	RK73K2A 1/10W 33-J TP(TD)	1
				R910	0ZL49201JA	CP-R-CARBON	RK73K2A 1/10W 200-J TP(TD)	1
				R911	0ZL49683JA	CP-R-CARBON	RK73K2A 1/10W 68K-J TP(TD)	1
				R912	0ELC9333JL	R-METAL.OX	RSS 2 L15 33K-J	1
				R913	0ZL49333JA	CP-R-CARBON	RK73K2A 1/10W 33K-J TP(TD)	1
				R914	0ZL49332JA	CP-R-CARBON	RK73K2A 1/10W 3.3K-J TP(TD)	1
				R915	0ZL49123JA	CP-R-CARBON	RK73K2A 1/10W 12K-J TP(TD)	1
				R916	0ZL49333JA	CP-R-CARBON	RK73K2A 1/10W 33K-J TP(TD)	1
				R917	0ZL49470JA	CP-R-CARBON	RK73K2A 1/10W 47-J TP(TD)	1
				R921	0ZL49682JA	CP-R-CARBON	RK73K2A 1/10W 6.8K-J TP(TD)	1
				R922	0BL49823JA	CP-R-CARBON	RK73K2E 1/4W 82K-J TP(TD)	1
				R923	0BL49683JA	CP-R-CARBON	RK73K2E 1/4W 58K-J TP(TD)	1
				R924	0ZL49122JA	CP-R-CARBON	RK73K2A 1/10W 1.2K-J TP(TD)	1
				R925	0ZL49102JA	CP-R-CARBON	RK73K2A 1/10W 1.0K-J TP(TD)	1

A	M	S	X	SYMB.	CODE	NAME	DESCRIPTION	QTY
				R926	0ZL49202JA	CP-R-CARBON	RK73K2A 1/10W 2.0K-J TP(TD)	1
				R927	0ZL49822JA	CP-R-CARBON	RK73K2A 1/10W 8.2K-J TP(TD)	1
				R928	0ZL49182JA	CP-R-CARBON	RK73K2A 1/10W 1.8K-J TP(TD)	1
				R951	0FM321R5JN	R-WIREWOUND	BWR 3N 1.5-J	1
				R952	0ZL49563JA	CP-R-CARBON	RK73K2A 1/10W 56K-J TP(TD)	1
				R953	0BL49334JA	CP-R-CARBON	RK73K2E 1/4W 330K-J TP(TD)	1
				R954	0ZL49562JA	CP-R-CARBON	RK73K2A 1/10W 5.6K-J TP(TD)	1
				R955	0BL08221JL	R-FUSING	RF25SJ 1/4W 220-J L(L10)	1
				R956	0ZL49683JA	CP-R-CARBON	RK73K2A 1/10W 68K-J TP(TD)	1
				R957	0ZL49224JA	CP-R-CARBON	RK73K2A 1/10W 220K-J TP(TD)	1
				R958	0BL49273JA	CP-R-CARBON	RK73K2E 1/4W 27K-J TP(TD)	1
				R959	0BL49273JA	CP-R-CARBON	RK73K2E 1/4W 27K-J TP(TD)	1
				R960	0ZL49392JA	CP-R-CARBON	RK73K2A 1/10W 3.9K-J TP(TD)	1
				R961	0ZL49222JA	CP-R-CARBON	RK73K2A 1/10W 2.2K-J TP(TD)	1
				R962	0ZL49474JA	CP-R-CARBON	RK73K2A 1/10W 470K-J TP(TD)	1
				R963	0ZL49681JA	CP-R-CARBON	RK73K2A 1/10W 680-J TP(TD)	1
				R964	0ZL49563JA	CP-R-CARBON	RK73K2A 1/10W 56K-J TP(TD)	1
				R965	0ZL49393JA	CP-R-CARBON	RK73K2A 1/10W 39K-J TP(TD)	1
				R971	0ZL49103JA	CP-R-CARBON	RK73K2A 1/10W 10K-J TP(TD)	1
				R972	0ZL49223JA	CP-R-CARBON	RK73K2A 1/10W 22K-J TP(TD)	1
				R973	0ZL49683JA	CP-R-CARBON	RK73K2A 1/10W 68K-J TP(TD)	1
				R975	0ZL49183JA	CP-R-CARBON	RK73K2A 1/10W 18K-J TP(TD)	1
				R976	0ZL49473JA	CP-R-CARBON	RK73K2A 1/10W 47K-J TP(TD)	1
				RY511	09F39101A1	RELAY	JV-12-KT	1
				RY512	09F39101A1	RELAY	JV-12-KT	1
				RY513	09F39101A1	RELAY	JV-12-KT	1
				RY515	09F39101A1	RELAY	JV-12-KT	1
S				RY901	09F39101A1	RELAY	JV-12-KT	1
				SW351	08F45784T1	SW-TACT	SKHVPA	1
				SW352	08F45784T1	SW-TACT	SKHVPA	1
				SW353	08F45784T1	SW-TACT	SKHVPA	1
				T501	0AF13003A1	TRANS-H.DRIVE	A1400168	1
				T531	0AF13002A1	TRANS	ETS29AC289AC	1
S	X			T701	05F13749A1	F.B.T	MSU1FUS11 5610220	1
				(T701)	05S90043A1	SCREW	B-TITE-P-TP 3X10 ZN/FE	3
S				T901	05F13809A1	TRANS	ETS39AF2Z5NC	1
				TP701	00J44862A2	PIN-TP	IRT-01T-1.0B	1
				TP921	00J44862A2	PIN-TP	IRT-01T-1.0B	1
A				U101	00G8E010AE	CP-IC	TC74HCT86AF-EL	1
A				U201	00G8B004AA	IC	CXA2055P	1
A				U351	00G8D010AA	IC	M37221M4-117SP	1
A				U351	05V20047A1	IC	ASSY MIC@N MS-2931	OR
A				(U351)	00G8D006AA	IC	M37221EFSP	1
A				U352	08J26126A1	CP-IC	M51951AML-600C-A	1
A				U353	00G8D004AA	IC	NM24C02EN	1
A				U353	00G8D005AA	IC	24LC02B-1/P	OR
A	M			U354	09F26519T2	CP-IC	M62392FP	1
				U401	09F26068A1	IC	LA7846N	1
				(U401)	09F52087B1	INSULATOR	E-1060	1
A				U451	00J26774A2	CP-IC	M5233FP-600C-B	1
				U531	09F26023A1	IC	LA6500-FA	1
				(U531)	08F52022A1	INSULATOR	M-30(13X18)D-1 DSN-CSSX-G53003	1
				(U531)	00J49987A1	INSULATOR	INSULATOR 25K (B-24)	1
				(U531)	00R49068A2	RADIATOR	OSH-2425-SPL	1
				(U531)	0FF623010D	SCREW	SC-SEMS-P-PAN M3X10(W/SW) ZN/FE	1
				U601	09F26381A1	IC	UPC1883BCT	1
A				U602	08N26343A5	IC	UPC78M09AHF	1
A	S	X		U701	09F26239A1	ASSY PCB-PCS	MSPAC004	1
A	M			U901	00G8C005AD	CP-IC	M62281FP	1
A				U921	01F26854A7	IC	UPC2412AHF	1
A				U922	01F26854A1	IC	UPC2405AHF	1
				U923	08R26113T1	CP-IC	AN1431M	1
A	M			U951	00G8C006AE	CP-IC	M62501FP	1
A				U971	00J26324A3	CP-IC	M5223FP-600C-C	1

A	M	S	X	SYMB.	CODE	NAME	DESCRIPTION	QTY
				VR501	00H13473WB	R-SEMX	RH063LCS4R-47KB	1
			X	VR711	00H13103WB	R-SEMX	RH063LC14R-10KB	1
			X	VR721	00H13473WB	R-SEMX	RH063LCS4R-47KB	1
				VR921	00H13102WB	R-SEMX	RH063LC13R-1KB	1
				X351	08R38626A1	CP-OSC	CSACS8.00MT-TC TP(SMD)	1
				ZD101	00N25729B8	D-ZENER	HZS2.7NB2TD	1
				ZD201	00N25709T2	D-ZENER	HZS36-2LTD	1
				ZD202	00N25709T2	D-ZENER	HZS36-2LTD	1
				ZD203	00N25709T2	D-ZENER	HZS36-2LTD	1
				ZD351	08H25125B4	CP-D-ZENER	MA8056-M (TX)	1
				ZD352	08H25125B4	CP-D-ZENER	MA8056-M (TX)	1
				ZD353	08H25125B4	CP-D-ZENER	MA8056-M (TX)	1
				ZD354	08H25125B4	CP-D-ZENER	MA8056-M (TX)	1
				ZD355	08H25125B4	CP-D-ZENER	MA8056-M (TX)	1
				ZD356	08H25125B4	CP-D-ZENER	MA8056-M (TX)	1
				ZD357	08H25125B4	CP-D-ZENER	MA8056-M (TX)	1
				ZD358	08H25125B4	CP-D-ZENER	MA8056-M (TX)	1
				ZD381	00N25734B3	D-ZENER	HZS11NB3TD	1
				ZD531	00N25498T3	D-ZENER	HZS2CLLTD	1
				ZD601	00N25732B5	D-ZENER	HZS6.8NB2TD	1
			X	ZD711	00N25706T8	D-ZENER	HZS18-2LTD	1
				ZD901	00N25736B5	D-ZENER	HZS22NB2TD	1
				ZD902	00N25739B2	D-ZENER	HZS36NB2TD	1
				(ASSY HV)	08J54319A1	EDGE-SADDLE	EDGE-SADDLE EDS-3	1
				(ASSY HV)	05D07636C1	RADIATOR	RADIATOR PV	1
				(ASSY HV)	05S90043A1	SCREW	TAP-TITE-SCREW B-TITE-P-TP 3X10 ZN/FE	5

A	M	S	X	SYMB.	CODE	NAME	DESCRIPTION	QTY
***** ASS'Y PCB CRT *****								
				C301	0KH80331JM	C-CERAMIC	DD107-959 SL 331J 50V (TP)	1
				C302	0KH81222KB	C-CERAMIC	DD106-999 B 222K 50V (TP)	1
				C311	0KH80331JM	C-CERAMIC	DD107-959 SL 331J 50V (TP)	1
				C312	0KH81222KB	C-CERAMIC	DD106-999 B 222K 50V (TP)	1
				C321	0KH80331JM	C-CERAMIC	DD107-959 SL 331J 50V (TP)	1
				C322	0KH81222KB	C-CERAMIC	DD106-999 B 222K 50V (TP)	1
				C331	02L81102KB	C-CERAMIC	DE0907-1 B 102K 2KV (SRT)	1
				C332	0RP41100MW	C-EL	KME 250V 10MF-M MC 10X20	1
				C341	02L81222KB	C-CERAMIC	DE1207-1 B 222K 2KV (SRT)	1
				CN301	00F44547B1	PIN-GT	2.36φ GT-PIN	1
				CN302	00J40642A5	CONNECTOR	B6B-PH-K-S	1
				CN303	00F40953A4	CONNECTOR	B5B-XH-A	1
				D301	00J25891A1	DIODE	1SS133 T-77	1
				D302	00N25030T1	DIODE	1SS244 T-77	1
				D303	00N25030T1	DIODE	1SS244 T-77	1
				D311	00J25891A1	DIODE	1SS133 T-77	1
				D312	00N25030T1	DIODE	1SS244 T-77	1
				D313	00N25030T1	DIODE	1SS244 T-77	1
				D321	00J25891A1	DIODE	1SS133 T-77	1
				D322	00N25030T1	DIODE	1SS244 T-77	1
				D323	00N25030T1	DIODE	1SS244 T-77	1
				L301	00L13120KT	AXIAL-COIL	LF5.0S 120 T26 K	1
				L302	00L134R7KT	AXIAL-COIL	LF5.0S 4R7 T26 K	1
				L311	00L13120KT	AXIAL-COIL	LF5.0S 120 T26 K	1
				L312	00L134R7KT	AXIAL-COIL	LF5.0S 4R7 T26 K	1
				L313	00L13100KT	AXIAL-COIL	LF5.0S 100 T26 K	1
				L321	00L13100KT	AXIAL-COIL	LF5.0S 100 T26 K	1
				L322	00L134R7KT	AXIAL-COIL	LF5.0S 4R7 T26 K	1
				L323	00L13100KT	AXIAL-COIL	LF5.0S 100 T26 K	1
				L324	00L13120KT	AXIAL-COIL	LF5.0S 120 T26 K	1
				Q301	0CH21740SZ	TR	2SC1740S TP E,Q,R,S	1
				Q302	0CF24001ZL	TR	2SC4001-L	1
				(Q302)	0PF723010Z	SCREW	SC-P-PAN-PC M3X10	1
				(Q302)	38R49039A1	RADIATOR	OSH1025-SPL	1
				(Q302)	08R49039A1	RADIATOR	OSH-1025-SPL	OR
				(Q302)	30N0D023A1	RADIATOR	BPUE10-25	OR
				(Q302)	00N0D023A1	RADIATOR	BPUE10-25	OR
				(Q302)	09F52327A1	INSULATOR	TF RUBBER	1
				Q303	0CH24218ZZ	TR	2SC4218 AA	1
				Q304	0AH21624ZZ	TR	2SA1624 AA	1
				Q311	0CH21740SZ	TR	2SC1740S TP E,Q,R,S	1
				Q312	0CF24001ZL	TR	2SC4001-L	1
				(Q312)	0PF723010Z	SCREW	SC-P-PAN-PC M3X10	1
				(Q312)	38R49039A1	RADIATOR	OSH1025-SPL	1
				(Q312)	08R49039A1	RADIATOR	OSH-1025-SPL	OR
				(Q312)	30N0D023A1	RADIATOR	BPUE10-25	OR
				(Q312)	00N0D023A1	RADIATOR	BPUE10-25	OR
				(Q312)	09F52327A1	INSULATOR	TF RUBBER	1
				Q313	0CH24218ZZ	TR	2SC4218 AA	1
				Q314	0AH21624ZZ	TR	2SA1624 AA	1
				Q321	0CH21740SZ	TR	2SC1740S TP E,Q,R,S	1
				Q322	0CF24001ZL	TR	2SC4001-L	1
				(Q322)	0PF723010Z	SCREW	SC-P-PAN-PC M3X10	1
				(Q322)	38R49039A1	RADIATOR	OSH1025-SPL	1
				(Q322)	08R49039A1	RADIATOR	OSH-1025-SPL	OR
				(Q322)	30N0D023A1	RADIATOR	BPUE10-25	OR
				(Q322)	00N0D023A1	RADIATOR	BPUE10-25	OR
				(Q322)	09F52327A1	INSULATOR	TF RUBBER	1
				Q323	0CH24218ZZ	TR	2SC4218 AA	1
				Q324	0AH21624ZZ	TR	2SA1624 AA	1
				R300	0BK10471JT	R-CARBON	KRDS2T 1/4W 470-J TP	1
				R301	0BK10121JT	R-CARBON	KRDS2T 1/4W 120-J TP	1

A	M	S	X	SYMB.	CODE	NAME	DESCRIPTION	Q'TY
				R302	0BK10220JT	R-CARBON	KRDS2T 1/4W 22-J TP	1
				R303	0CL04224JT	R-CARBON	RD50SS T26 1/2W 220K-J TP	1
				R304	0BK10183JT	R-CARBON	KRDS2T 1/4W 18K-J TP	1
				R305	0HM37562J1	R-CEMENT	BSR5YS 5.6K-J	1
				R306	0BL08101JL	R-FUSING	RF25SJ 1/4W 100-J L(L10)	1
				R307	0CS79271JT	R-METAL GL	RCR50 T52 270-J TP	1
				R308	0BK10102JT	R-CARBON	KRDS2T 1/4W 1.0K-J TP	1
				R310	0BK10471JT	R-CARBON	KRDS2T 1/4W 470-J TP	1
				R311	0BK10121JT	R-CARBON	KRDS2T 1/4W 120-J TP	1
				R312	0BK10220JT	R-CARBON	KRDS2T 1/4W 22-J TP	1
				R313	0CL04224JT	R-CARBON	RD50SS T26 1/2W 220K-J TP	1
				R314	0BK10183JT	R-CARBON	KRDS2T 1/4W 18K-J TP	1
				R315	0HM37562J1	R-CEMENT	BSR5YS 5.6K-J	1
				R316	0BL08101JL	R-FUSING	RF25SJ 1/4W 100-J L(L10)	1
				R317	0CS79271JT	R-METAL GL	RCR50 T52 270-J TP	1
				R320	0BK10471JT	R-CARBON	KRDS2T 1/4W 470-J TP	1
				R321	0BK10121JT	R-CARBON	KRDS2T 1/4W 120-J TP	1
				R322	0BK10220JT	R-CARBON	KRDS2T 1/4W 22-J TP	1
				R323	0CL04224JT	R-CARBON	RD50SS T26 1/2W 220K-J TP	1
				R324	0BK10183JT	R-CARBON	KRDS2T 1/4W 18K-J TP	1
				R325	0HM37562J1	R-CEMENT	BSR5YS 5.6K-J	1
				R326	0BL08101JL	R-FUSING	RF25SJ 1/4W 100-J L(L10)	1
				R327	0CS79271JT	R-METAL GL	RCR50 T52 270-J TP	1
				R331	0CS79105JT	R-METAL GL	RCR50 T52 +1M-J TP	1
				R332	0CG08106JT	R-METAL	RK14B2H 10M-J TP	1
				R341	0CL04473JT	R-CARBON	RD50SS T26 1/2W 47K-J TP	1
				SG301	08R38116A1	SPARK-GAP	RA-102M-V6-Y-2	1
				SG311	08R38116A1	SPARK-GAP	RA-102M-V6-Y-2	1
				SG321	08R38116A1	SPARK-GAP	RA-102M-V6-Y-2	1
				SG333	09F38065A1	SPARK-GAP	RA-231M-V6-Y-2(RADIAL)	1
S				SK301	09F43293A1	CRT-SOCKET	CVT3240-0932	1
				ZD301	00N25735B2	D-ZENER	HZS15NB2TD	1
				ZD311	00N25735B2	D-ZENER	HZS15NB2TD	1
				ZD321	00N25735B2	D-ZENER	HZS15NB2TD	1
				ZZ001	05DC6966A1	PCB-COVER	PCB-COVER MS9-29	1
				ZZ002	08N54089A1	CLAMPER	T18R	1
**** OTHERS ****								
S				00MCA052A1	ASSY-CN-SE	(for -S/SW only)		1
				00MCA016A1	ASSY-CN353	(for -AW only)		1
				00MCA050A1	ASSY-CN352S	(for -AW only)		1
				00MCA051A1	ASSY-CN353S	(for -AW only)		1
				05A20008A1	BASE-2931			1
				08N54105A1	CLAMPER	PLT1M		6
				08N54089A1	CLAMPER	T18R		OR
				05D07812A1	EDGE-COVER			1
				05D20186A1	LABEL	LABEL-CN (for -S/SW only)		1
				05D20154B1	LABEL	LABEL-HV-FUSE		1
				00NCH001A1	NUT	belongs to 00M05007A1		2
				08R66409A1	NUT	belongs to 08R40362A1, A2		OR
S				05B20010A1	PCB-BASE			1
				05C20098A1	PLATE-CN			1
				00R54243A1	PWD-HOLDER	#1429		2
				05S90043A1	SCREW	TAP-TITE-P-TP 3-TYPE 3*10 Zn/Fe		7
				08N54362A1	WIRE-HOLDER	HL-28-0		1
				08R54031A1	WIRE-SADDLES	LWS-2NA RICHCO		1

A	M	S	X	SYMB.	CODE	NAME	DESCRIPTION	QTY			
								SW	AW	S	A
2. OTHERS											
					.09F51156A1	ANODE RING	ANR-65	1	1	1	1
					.05P20059A1	ASSY COATING EARTH		1	1	1	1
				(C-EARTH)	.00F09500A2	SHIELD-WIRE	120/0.12T	3	3	3	3
				(C-EARTH)	.05D03719A1	SPRING		1	1	1	1
				(C-EARTH)	.05V10564D1	COATING-WIRE		1	1	1	1
				(C-EARTH)	.08N54105A1	CLAMPER	PLT-1M	2	2	2	2
				(C-EARTH)	.08N54089A1	CLAMPER	T18R	OR	OR	OR	OR
S					.3AF16002A1	ASSY DG COIL		1	1	1	1
S					.05P20060A1	ASSY DG COIL		OR	OR	OR	OR
				(DG COIL)	.00N09453A8	WIRE-COPPER	1μEW φ0.6	2	2	2	2
				(DG COIL)	.05V03524A1	DG WIRE		1	1	1	1
				(DG COIL)	.08N54105A1	CLAMPER	PLT-1M	1	1	1	1
				(DG COIL)	.08N54089A1	CLAMPER	T18R	OR	OR	OR	OR
					.05C02749B1	ASSY PALLET		1/2	1/2	/	/
					.05C02911B1	BRACKET	BRACKET-29VGA	2	2	2	2
					.08N50441A1	C.P MAGNET	ETC33X8KA	1	1	1	1
					.00J50821A1	C.P MAGNET	2771831	OR	OR	OR	OR
					.09F54329A1	CLAMPER	T18R-V0	6	6	6	6
S	X				.09F31599A1	CRT	A68LBT696X	1	1	1	1
					.05S90059A1	CRT-SCREW		4	4	4	4
					.05A00737B1	CUSHION	CUSHION-29NF	/	/	2	2
S					.05F18745A1	DY	KDY4UW555R	1	1	1	1
					.05D07063A2	HOLDER	HOLDER-29	4	4	4	4
					.05D20055A1	LABEL	LABEL-HV	4	4	4	4
					.05D06327A1	LABEL	LABEL-S	1	/	1	/
					.05D06983A1	LABEL	LABEL-B	1	/	1	/
					.05D07882B1	LABEL	LABEL-PTB	1	1	1	1
					.05D06444A1	LABEL	DHHS LABEL	1	1	1	1
					.05C02093A1	LABEL	BAR CODE LABEL	1	1	1	1
					.108F50377A1	MAGNET	102 + NITTO No.500	5/2	5/2	5/2	5/2
					.09F50363A1	MAGNET	TIC8016	1	1	1	1
					.09F50364A1	MAGNET	TIC8065B	1	1	1	1
					.05D07401A3	MONITOR-BAG	t=0.05 GREEN	1/2	1/2	/	/
S					.05D20106C1	N.P	N.P-2931-NNO	1	1	1	1
					.05C20055B1	PACKING-CASE		/	/	1	1
					.05D06393A1	PAD	PAD FSG	/	/	1	1
					.05C02935A1	PAD	PAD TOP	/	/	2	2
					.05D07069A1	PALLET-SUPPORTER		1	1	/	/
					.100F55550A1	PLASTI-RIVET	No.615	/	1	/	1
					.08R50047A1	RUBBER MAGNET	B-1030 NITRILE	3	3	3	3
					.0FJ924008D	SCREW	B-TITE-P-BIND 4*8 Zn/Fe	4	4	4	4
					.0FN606014D	SCREW	SCREW-SEMS-P-HEX M6*14 (W/SW) Zn/Fe	5	5	4	4
					.05B01107B1	STAY	STAY-29VGA	2	2	2	2
					.05C02609A1	SUPPORT	SUPPORT-29S	1/2	1/2	/	/
					.05D20107B1	U.M	U.M-2931	1/2	1/2	1	1
					.08N46012A1	WEDGE	WEDGE-31	3	3	3	3
					.00F54549A2	WIRE-HOLDER	11.5B	1	1	1	1
3. ASSEMBLED PARTS											
					.05P20058A1	ASSY CHASSIS UNIT	(includes PCBs below)	1	/	1	/
					.05P20058A2	ASSY CHASSIS UNIT	(includes PCBs below)	/	1	/	1
S					---	ASSY PCB MAIN					
S					---	ASSY PCB CRT					

MS-2931-A/AW CONNECTION DIAGRAM

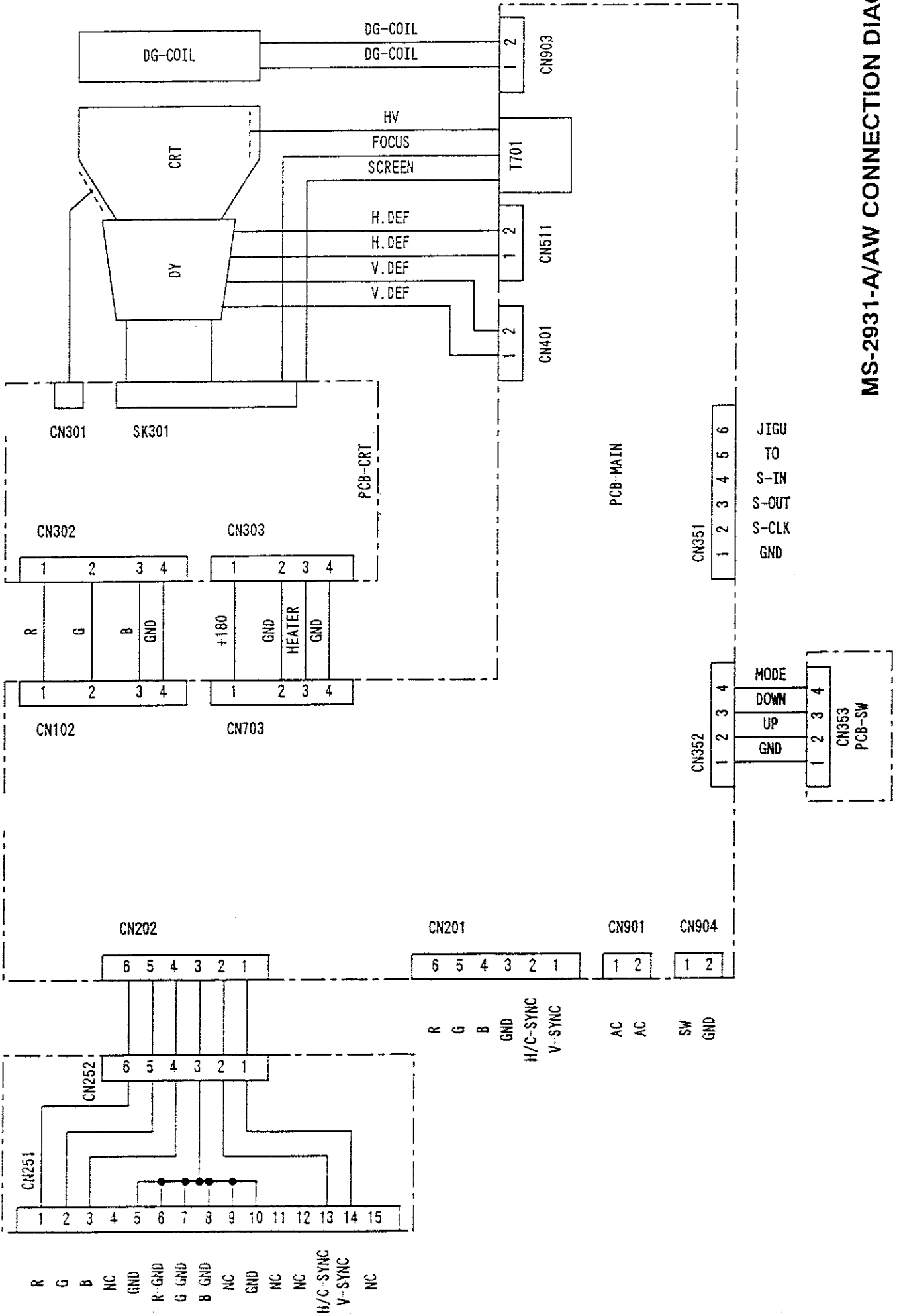

MS-2931-S/SW CONNECTION DIAGRAM

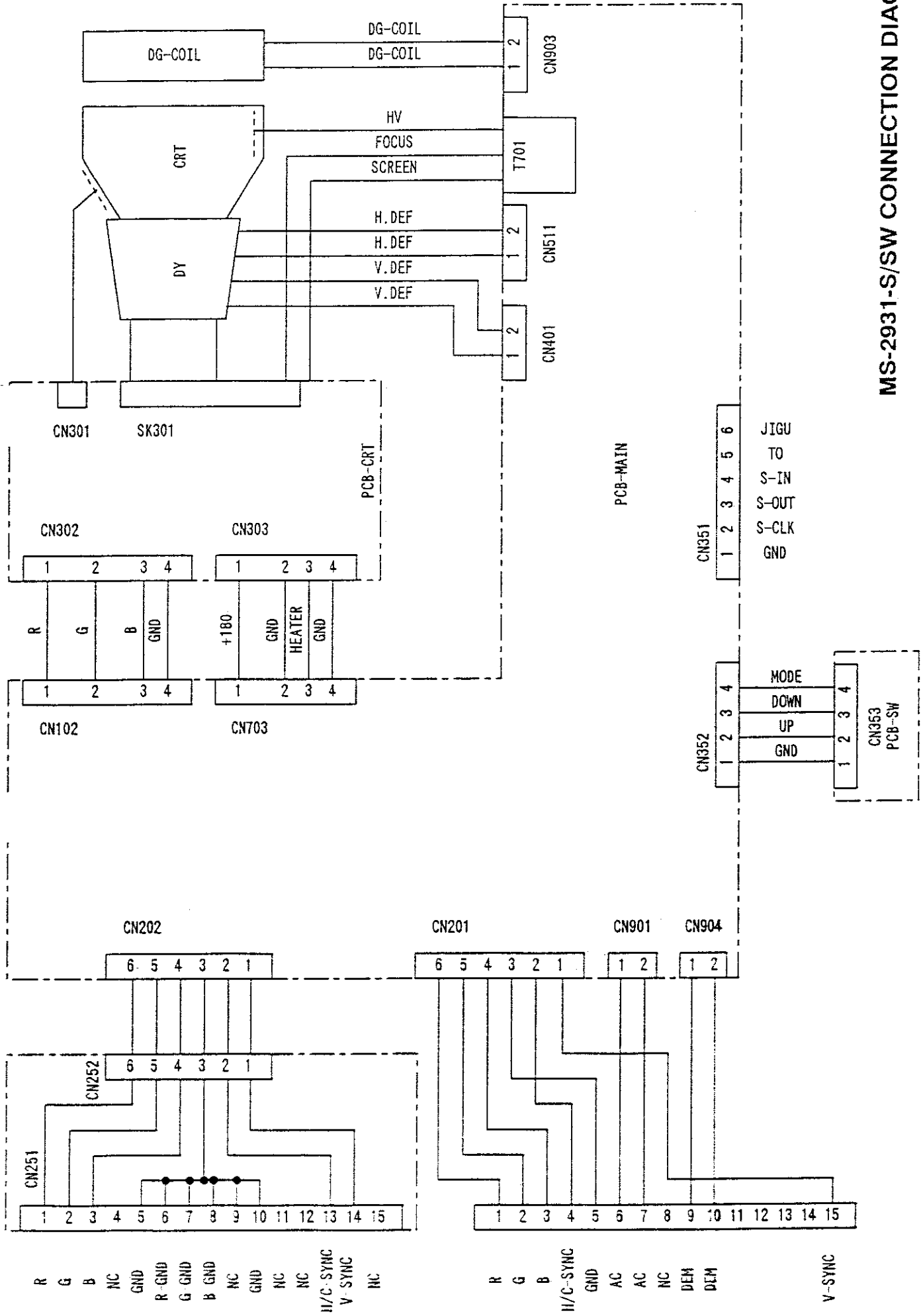

Missing area
 Very poorly scanned from start.
 Tried to patch it, but 2 cm wide
 column still remains blank.

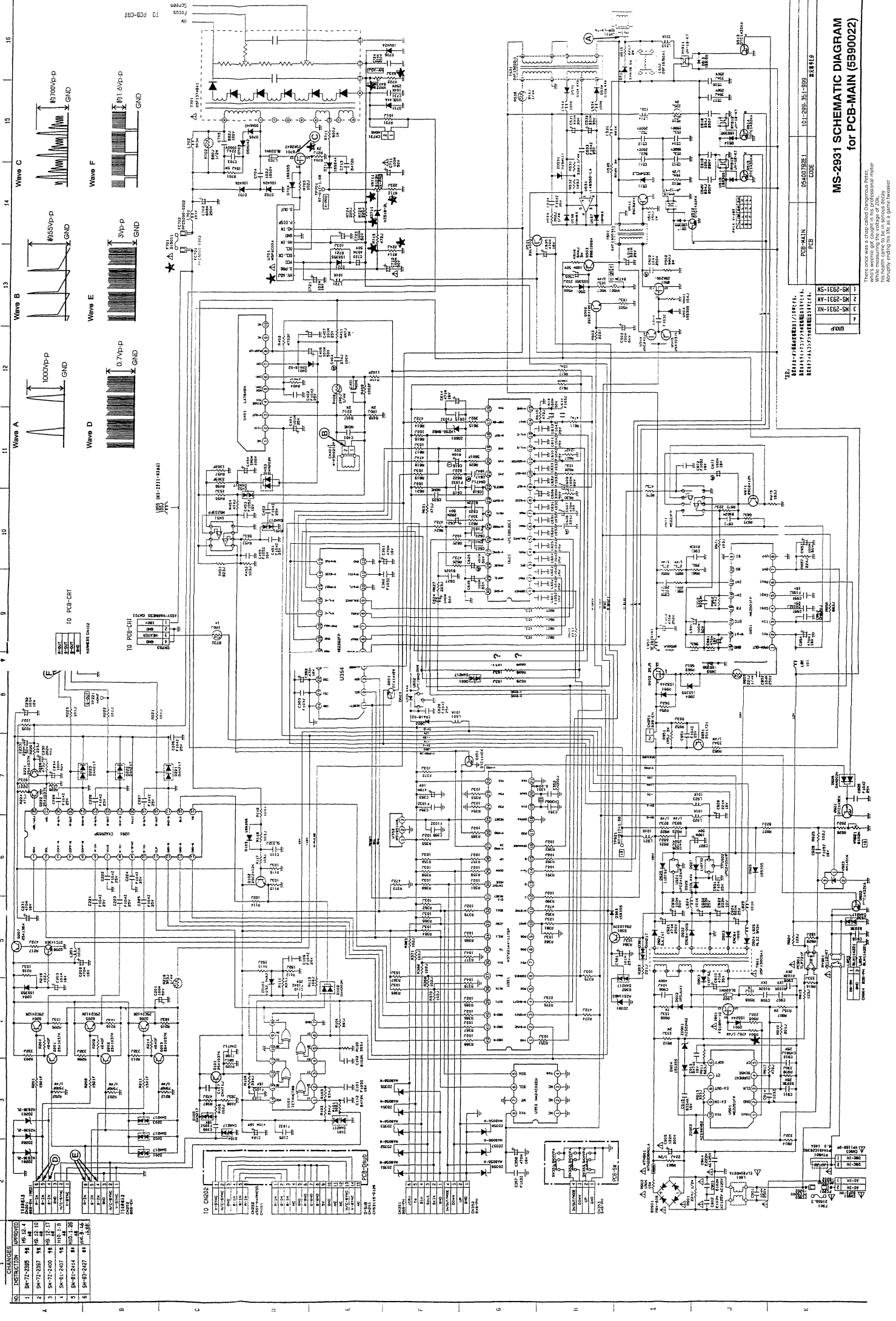

NO.	DESCRIPTION	QUANTITY	REV.
1	SH-72-2387	18	10
2	SH-72-2387	18	11
3	SH-72-2400	18	17
4	SH-81-2407	18	11
5	SH-81-2414	18	11
6	SH-82-2427	18	11

NO.	DESCRIPTION	QUANTITY	REV.
1	SH-82-2427	18	11
2	SH-82-2427	18	11
3	SH-82-2427	18	11
4	SH-82-2427	18	11
5	SH-82-2427	18	11
6	SH-82-2427	18	11

NO.	DESCRIPTION	QUANTITY	REV.
1	SH-82-2427	18	11
2	SH-82-2427	18	11
3	SH-82-2427	18	11
4	SH-82-2427	18	11
5	SH-82-2427	18	11
6	SH-82-2427	18	11

NO.	DESCRIPTION	QUANTITY	REV.
1	SH-82-2427	18	11
2	SH-82-2427	18	11
3	SH-82-2427	18	11
4	SH-82-2427	18	11
5	SH-82-2427	18	11
6	SH-82-2427	18	11

NO.	DESCRIPTION	QUANTITY	REV.
1	SH-82-2427	18	11
2	SH-82-2427	18	11
3	SH-82-2427	18	11
4	SH-82-2427	18	11
5	SH-82-2427	18	11
6	SH-82-2427	18	11

NO.	DESCRIPTION	QUANTITY	REV.
1	SH-82-2427	18	11
2	SH-82-2427	18	11
3	SH-82-2427	18	11
4	SH-82-2427	18	11
5	SH-82-2427	18	11
6	SH-82-2427	18	11

NO.	DESCRIPTION	QUANTITY	REV.
1	SH-82-2427	18	11
2	SH-82-2427	18	11
3	SH-82-2427	18	11
4	SH-82-2427	18	11
5	SH-82-2427	18	11
6	SH-82-2427	18	11

NO.	DESCRIPTION	QUANTITY	REV.
1	SH-82-2427	18	11
2	SH-82-2427	18	11
3	SH-82-2427	18	11
4	SH-82-2427	18	11
5	SH-82-2427	18	11
6	SH-82-2427	18	11

NO.	DESCRIPTION	QUANTITY	REV.
1	SH-82-2427	18	11
2	SH-82-2427	18	11
3	SH-82-2427	18	11
4	SH-82-2427	18	11
5	SH-82-2427	18	11
6	SH-82-2427	18	11

NO.	DESCRIPTION	QUANTITY	REV.
1	SH-82-2427	18	11
2	SH-82-2427	18	11
3	SH-82-2427	18	11
4	SH-82-2427	18	11
5	SH-82-2427	18	11
6	SH-82-2427	18	11

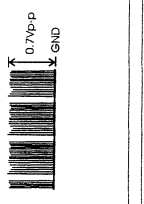
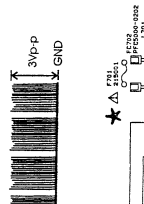
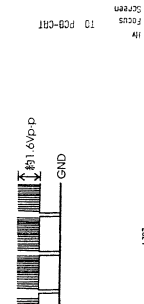
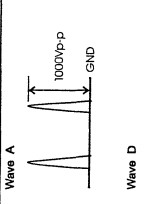
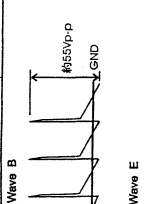
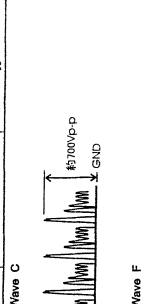

PCB-MAIN	PCB	CODE
05A027E01	01	05A027E01
05A027E01	02	05A027E01
05A027E01	03	05A027E01
05A027E01	04	05A027E01
05A027E01	05	05A027E01
05A027E01	06	05A027E01
05A027E01	07	05A027E01
05A027E01	08	05A027E01
05A027E01	09	05A027E01
05A027E01	10	05A027E01
05A027E01	11	05A027E01
05A027E01	12	05A027E01
05A027E01	13	05A027E01
05A027E01	14	05A027E01
05A027E01	15	05A027E01
05A027E01	16	05A027E01

MS-2931 SCHEMATIC DIAGRAM
 for PCB-MAIN (5B90022)

This data was a chip called Dangerous Part.
 While measuring the voltage of 20k.
 Accidentally using this as a part number.

Wave G

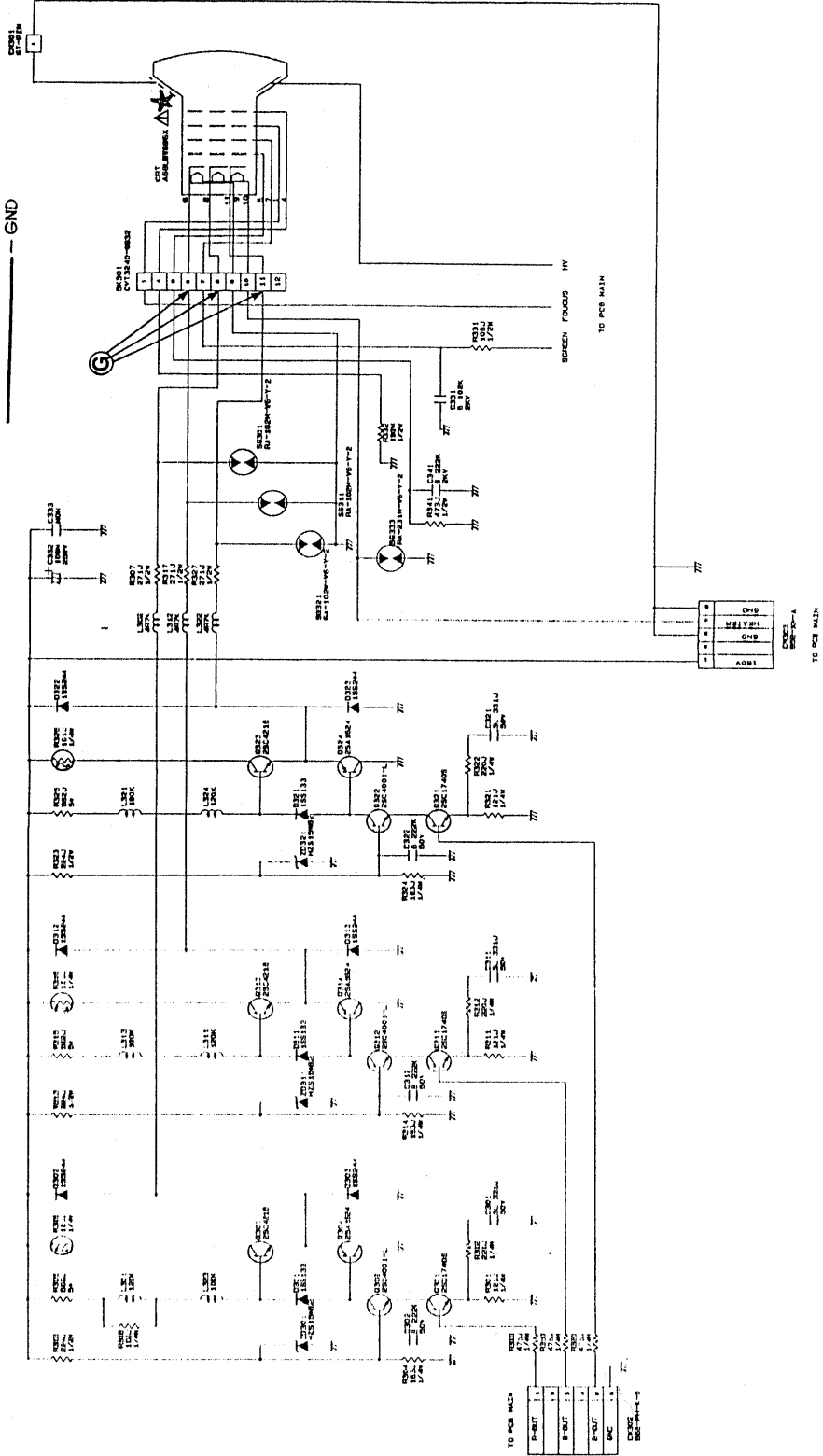

1	MS-2931
2	
3	
4	

GROUP	
1	GROUP
2	
3	
4	

PCB-CRT	05920019631	300-349	300-349
PCB	CODE		諸元番号区分

MS-2931 SCHEMATIC DIAGRAM
for PCB-CRT (5C90033)